

ONKYO SERVICE MANUAL

AV Receiver MODEL TX-SR507(B/S/G)

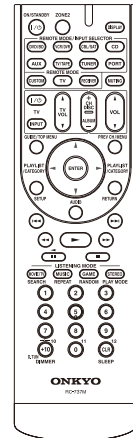
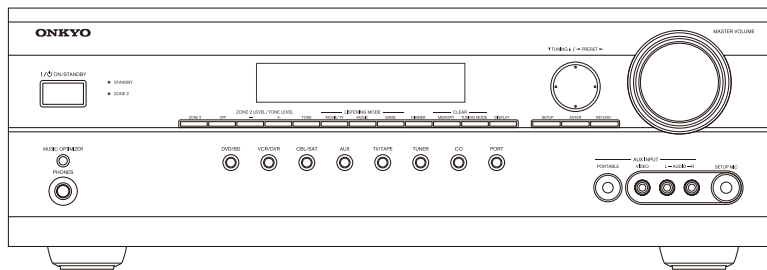

RC-737M

TX-SR507 Black, Silver and Golden models

B MDC, B MDD, S MDD, B MDF, G MDF	120V AC, 60Hz
B MPP, B MPB, S MPP, S MPB B MPA, S MPA	230V AC, 50Hz
B MMO, S MMO, B MMQ, G MMR	220/230-240V AC, 50/60Hz

SAFETY-RELATED COMPONENT WARNING!!

COMPONENTS IDENTIFIED BY MARK  ON THE SCHEMATIC DIAGRAM AND IN THE PARTS LIST ARE CRITICAL FOR RISK OF FIRE AND ELECTRIC SHOCK. REPLACE THESE COMPONENTS WITH ONKYO PARTS WHOSE PART NUMBERS APPEAR AS SHOWN IN THIS MANUAL.

MAKE LEAKAGE-CURRENT OR RESISTANCE MEASUREMENTS TO DETERMINE THAT EXPOSED PARTS ARE ACCEPTABLY INSULATED FROM THE SUPPLY CIRCUIT BEFORE RETURNING THE APPLIANCE TO THE CUSTOMER.

EXPLODED VIEWS-1

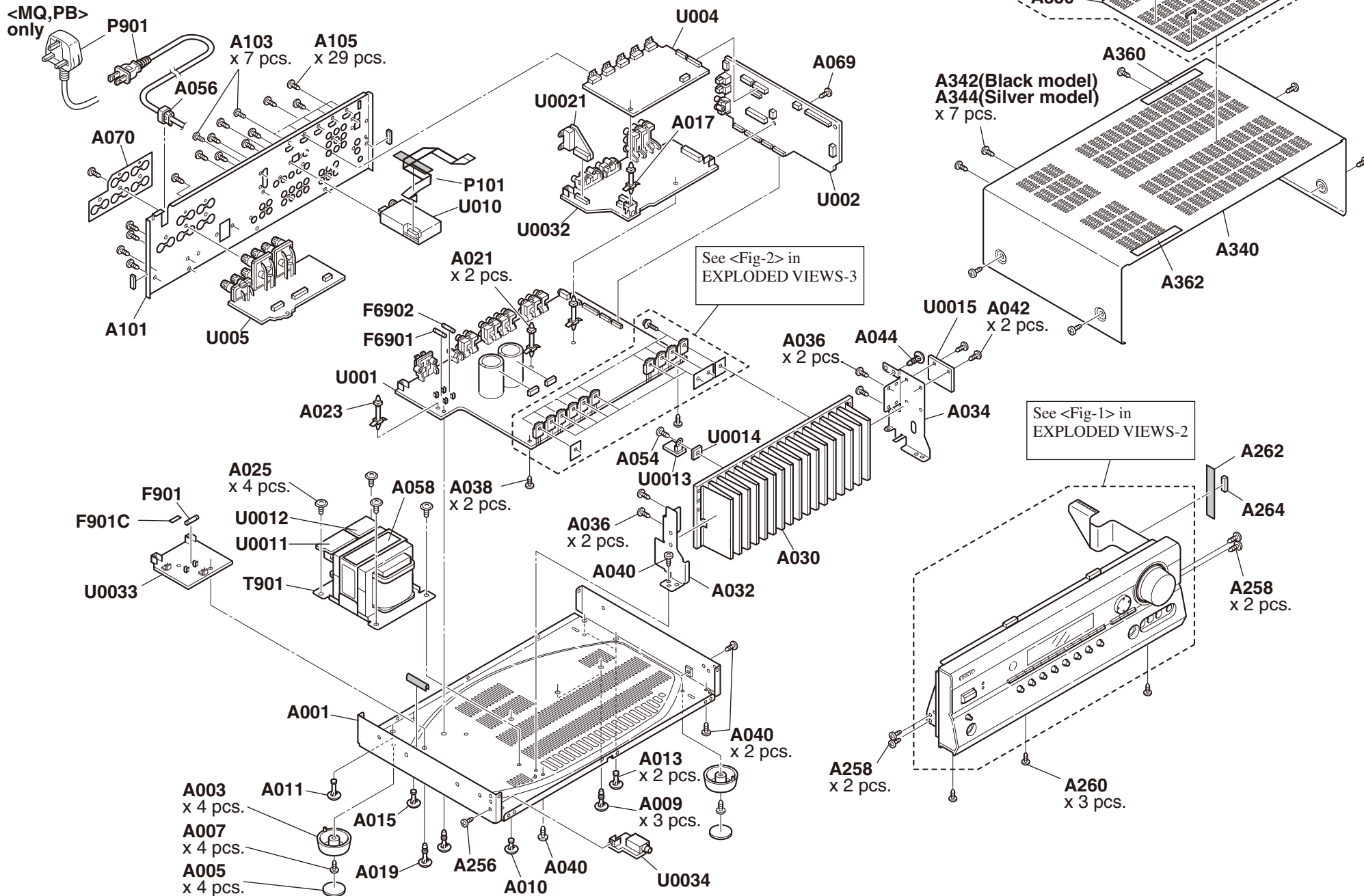

EXPLODED VIEWS-2

<Fig-1>

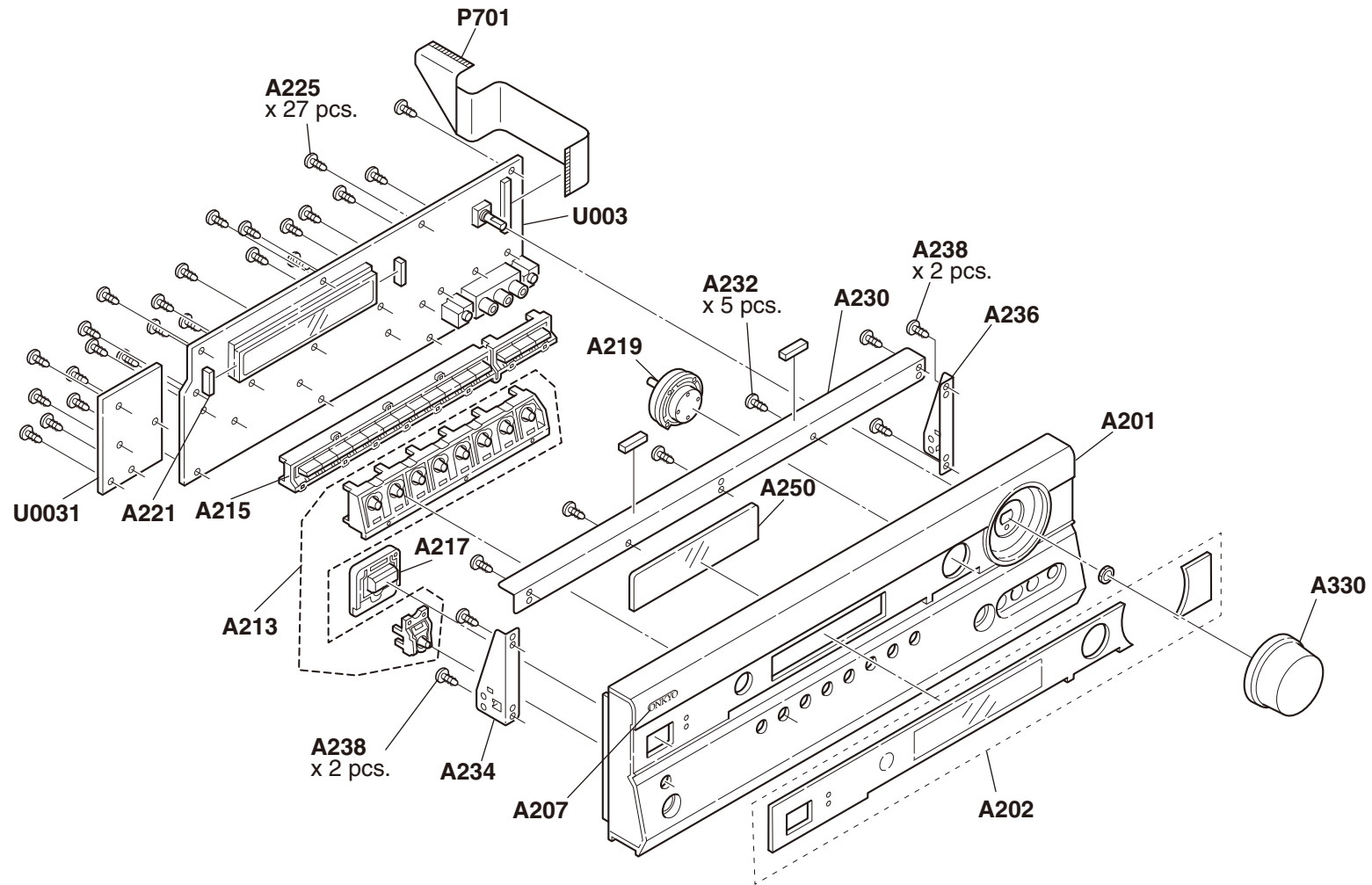

EXPLODED VIEWS-3

<Fig-2>

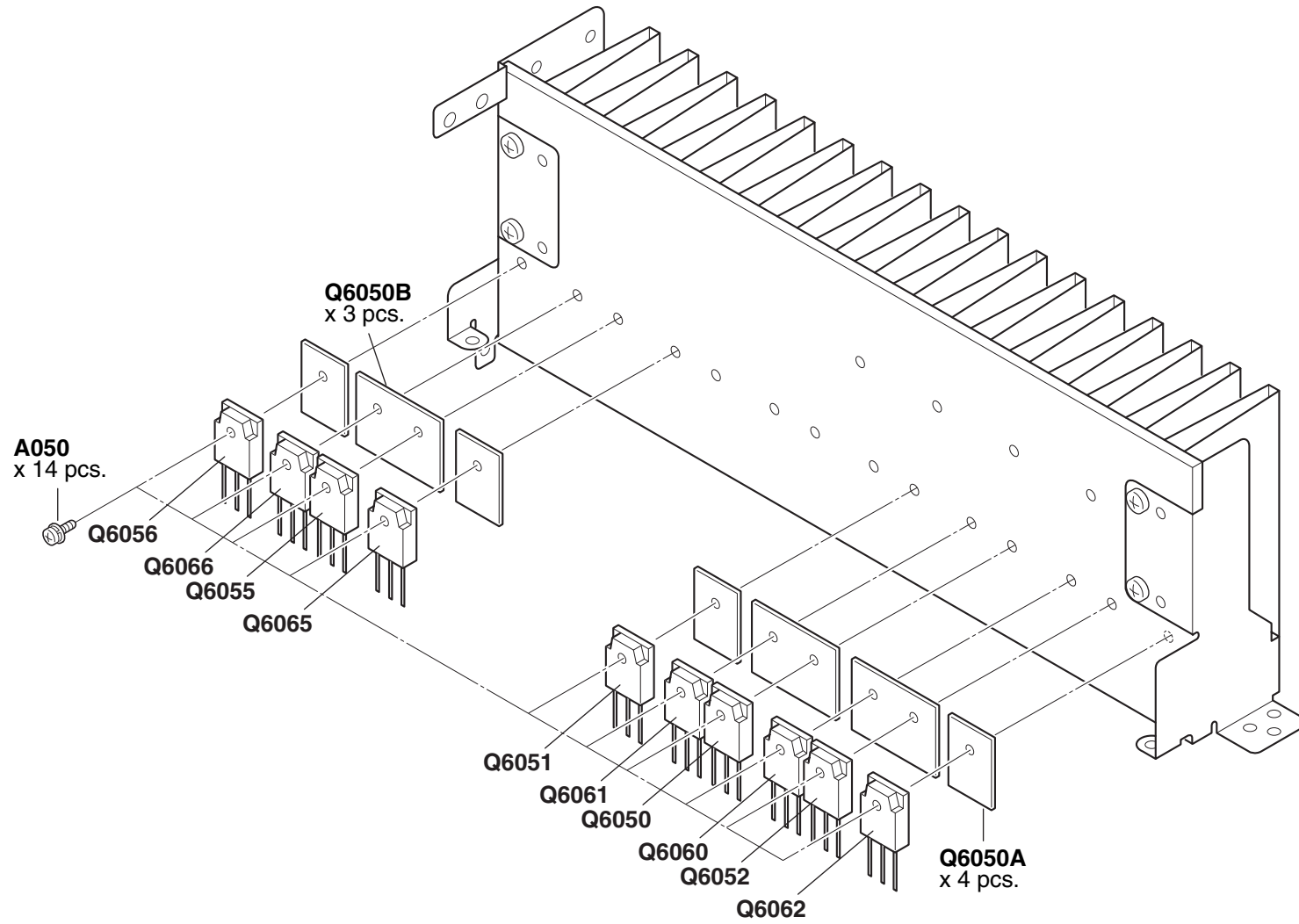

BLOCK DIAGRAMS-1 / PART-1
AUDIO SECTION

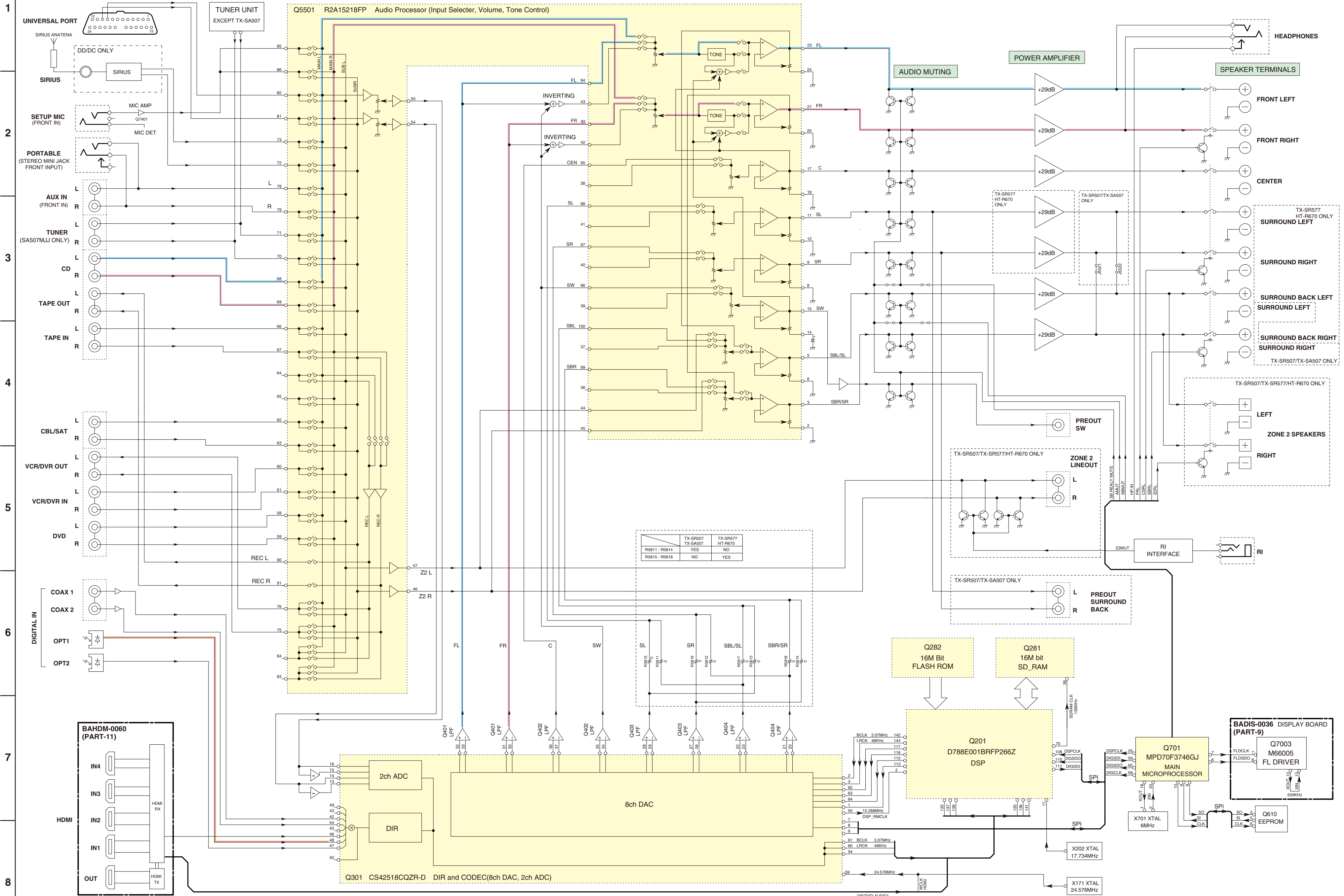

<Note>
Refer to SCHEMATIC DIAGRAM-3 / PART-5 and SCHEMATIC DIAGRAM-17 / PART-19
for digital audio signal waveforms.

BLOCK DIAGRAMS-2 / PART-2
VIDEO SECTION

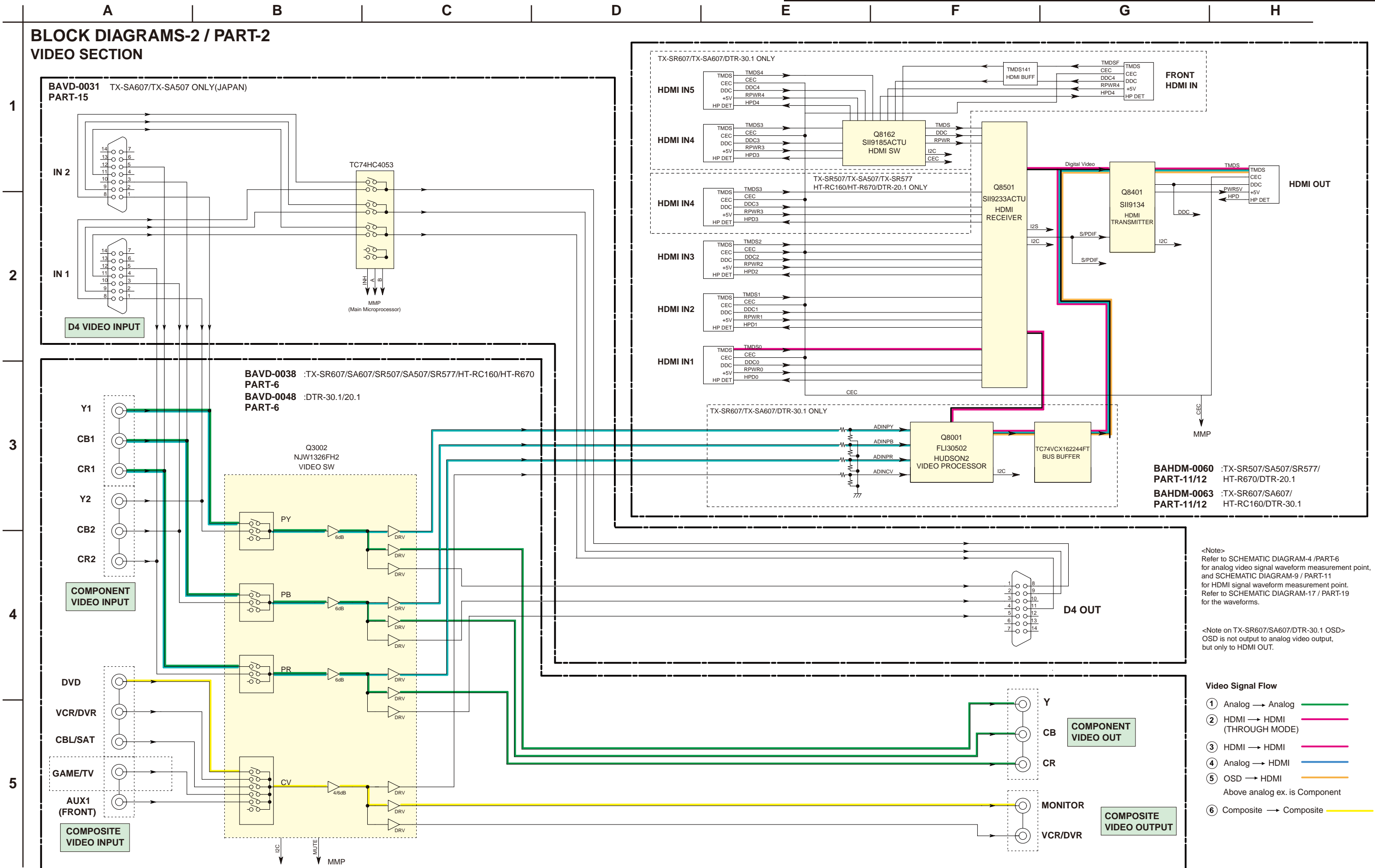

<Note>
Refer to SCHEMATIC DIAGRAM-4 /PART-6 for analog video signal waveform measurement point, and SCHEMATIC DIAGRAM-9 / PART-11 for HDMI signal waveform measurement point. Refer to SCHEMATIC DIAGRAM-17 / PART-19 for the waveforms.

<Note on TX-SR607/SA607/DTR-30.1 OSD>
OSD is not output to analog video output, but only to HDMI OUT.

- Video Signal Flow**
- ① Analog → Analog (Green line)
 - ② HDMI → HDMI (THROUGH MODE) (Pink line)
 - ③ HDMI → HDMI (Magenta line)
 - ④ Analog → HDMI (Blue line)
 - ⑤ OSD → HDMI (Yellow line)
Above analog ex. is Component
 - ⑥ Composite → Composite (Yellow line)

SCHEMATIC DIAGRAMS-2 / PART-4
POWER AMP SECTION

NOTE:
XY in "SCHEMATIC-a / PART-b:XY" indicates the target location of the plug or socket, X=A to E/H/K, Y=1 to 4/5/8.

BAAF-0008(2/2)

U001 AMPLIFIER PC BOARD

- NOTE
- THE COMPONENTS IDENTIFIED BY MARK Δ ARE CRITICAL FOR SAFETY. REPLACE ONLY WITH PART NUMBER SPECIFIED.
 - BOLD VOLTAGE (MEASURED WITH VOLTMETER) IS DC VOLTAGE (NO INPUT SIGNAL).
 - ALL PNP TRANSISTORS ARE EQUIVALENT TO 2SA1015-GR UNLESS OTHERWISE NOTED.
 - ALL NPN TRANSISTORS ARE EQUIVALENT TO 2SC1815-GR UNLESS OTHERWISE NOTED.
 - ALL DIODES ARE EQUIVALENT TO 1SS133 UNLESS OTHERWISE NOTED.
 - ELECTROLYTIC CAPACITORS ($\text{---}\text{||}$) ARE IN $\mu\text{F}/\text{V}$.
 - ALL CAPACITORS ARE IN $\mu\text{F}/\text{V}$ UNLESS OTHERWISE NOTED.
 - EX) 030-33F, 330-330F, 331-330F, 333-0.033F
 - ALL RESISTORS ARE IN OHMS 1/6 WATT UNLESS OTHERWISE NOTED.
 - THE THICK LINES ON PC BOARD ARE THE PRINTING SIDE OF THE PARTS.
 - EX) \square \square PRINTING SIDE
 - "NM" AND "NC" ARE SHORT FOR "NOT MOUNTED" AND "NOT CONNECTED", WHICH MEANS NO PART IS MOUNTED ON WIRING PATTERN OF PCB.
 - CIRCUIT IS SUBJECT TO CHANGE FOR IMPROVEMENT.

POWER TRANSISTOR LIST

	TX-SR507 HT-R670	TX-SR577 HT-R670	TX-SR507 PP TX-SA507
Q6050-Q6056	MN130S	MN130S	2SC5198
Q6060-Q6066	MP130S	MN130S	2SA1941

TO BAAF-0008(1/2)
PART-3:J2

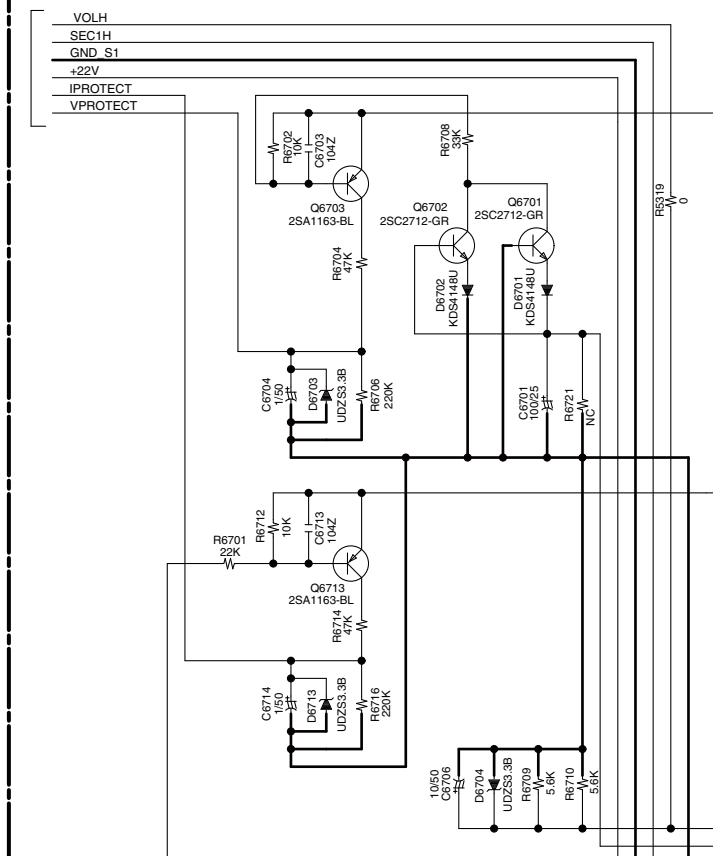

TO BAPS-0010
PART-3:A8

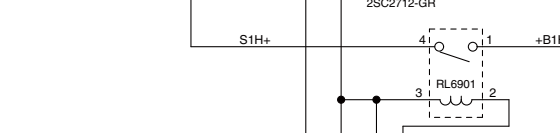

TO BAPS-0010
PART-3:A8

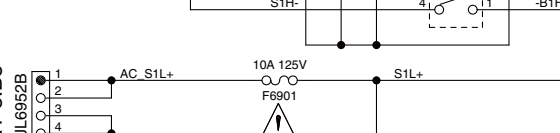

TO BAAF-0008(1/2)
PART-3:B8

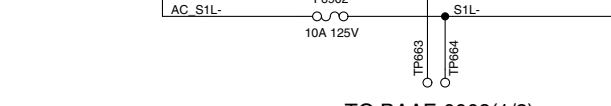

TO BAAF-0008(1/2)
PART-3:J2

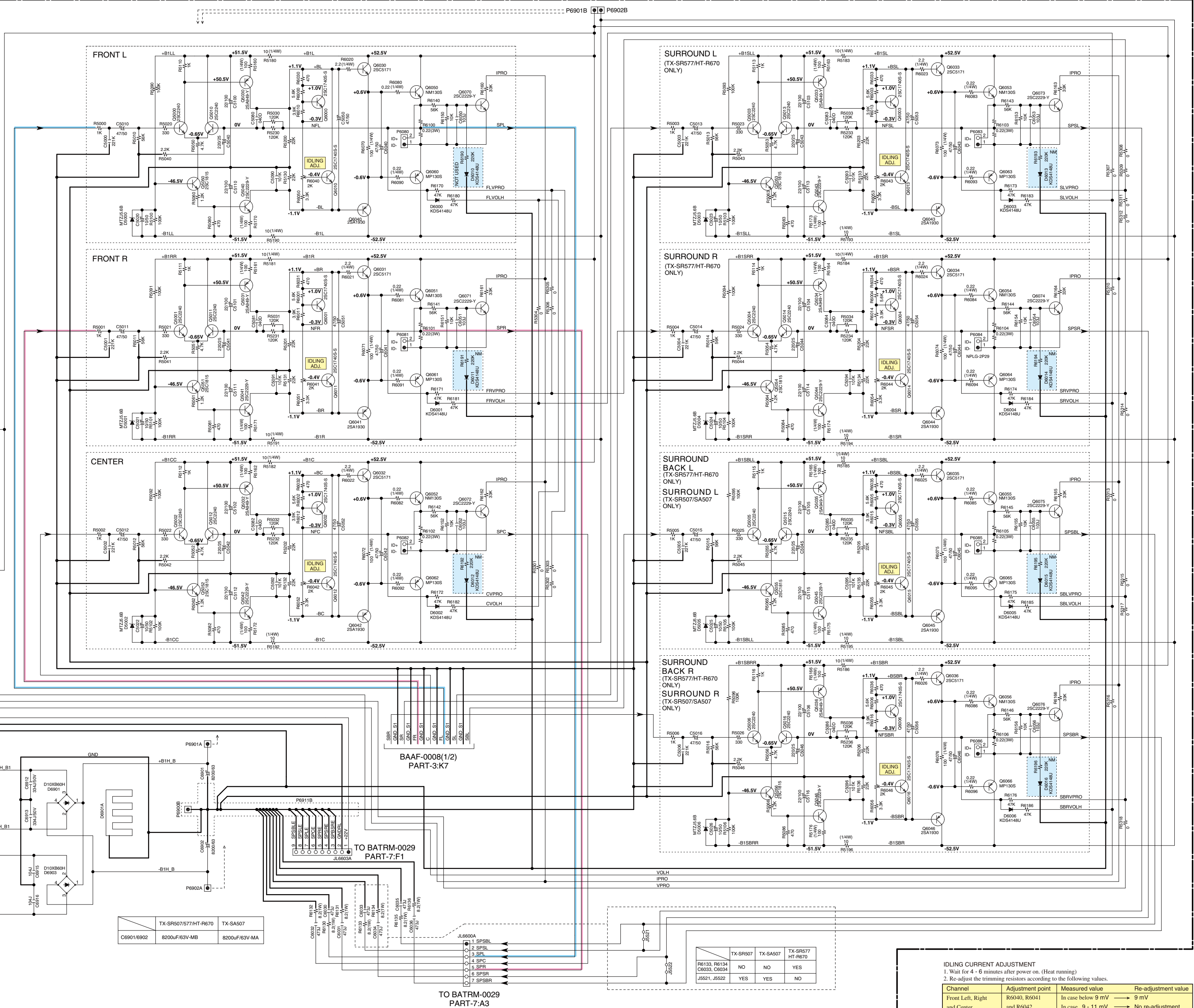

	TX-SR507/577/HT-R670	TX-SA507
C6901/6902	8200uF/63V-MB	8200uF/63V-MA

	TX-SR507	TX-SA507	TX-SR577 HT-R670
R6133, R6134	NO	NO	YES
C6933, C6934	NO	NO	YES
J5521, J5522	YES	YES	NO

IDLING CURRENT ADJUSTMENT

1. Wait for 4 - 6 minutes after power on. (Heat rming)
2. Re-adjust the trimming resistors according to the following values.

Channel	Adjustment point	Measured value	Re-adjustment value
Front Left, Right and Center	R6040, R6041 and R6042	In case below 9 mV In case 9 - 11 mV In case over 11mV	→ 9 mV → No re-adjustment → 11 mV
Surround Left	R6043, R6044	In case below 4 mV	→ 4 mV
Surround Right		In case 4 - 6 mV	→ No re-adjustment
Surround Back Left	R6045 and R6046	In case over 6 mV	→ 6 mV
Surround Back Right			

SCHEMATIC DIAGRAMS-7 / PART-9
DISPLAY SECTION

NOTE:
XY in "SCHEMATIC-a / PART-b:XY" indicates the target
location of the plug or socket, X=A to E/H/K, Y=1 to 4/5/8.

NOTE:
PART-10 is not used for TX-SR607/TX-SA507/TX-SR577.

BADIS-0036 U003 DISPLAY PC BOARD

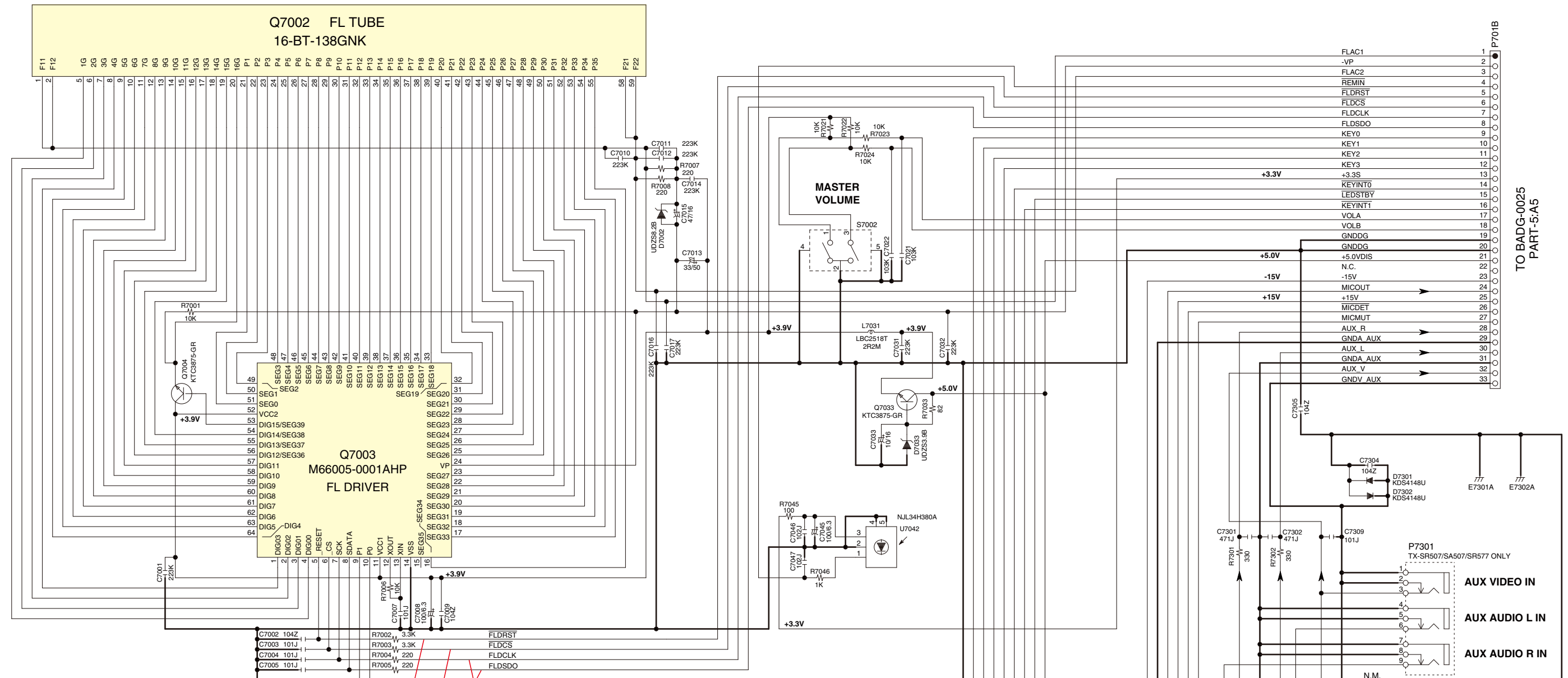

-Note-
Refer to SCHEMATIC DIAGRAM-19 / PART-17
for FL driver IC control waveforms.

JL7101A
JL7101B

BUTTON NAME

TX-SR607/SR577/SR607/HT-RC160 EXCEPT P/P/B	ZONE2	OFF	MEMORY	DIMMER	TUNING
TX-SR607/TX-SR577/TX-SR607 P/P/B	ZONE2	OFF	MEMORY	RT/TPTV/TP	TUNING
TX-SA607/TX-SA507	RI HD	MUSIC OPTIMIZER	CINEMA FILTER	DIMMER	LATE NIGHT
HT-R670/S70	SP-A	SP-B	MEMORY	DIMMER	TUNING

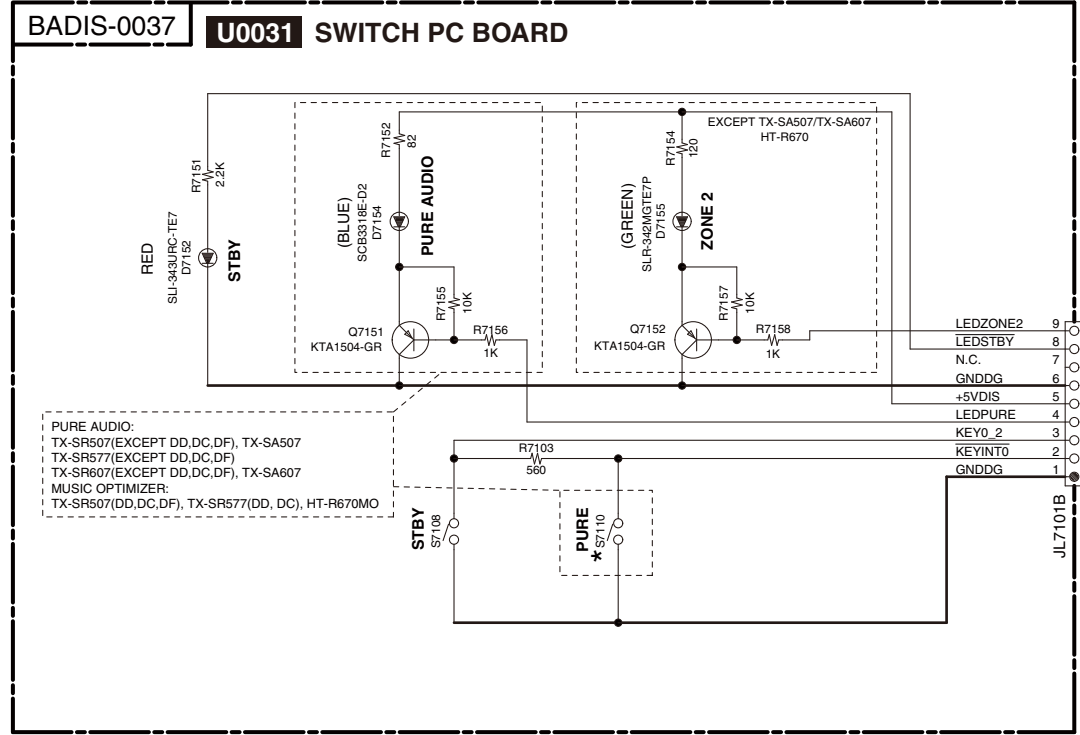

- NOTE
- THE COMPONENTS IDENTIFIED BY MARK ARE CRITICAL FOR SAFETY. REPLACE ONLY WITH PART NUMBER SPECIFIED.
 - BOLD VOLTAGE (MEASURED WITH VOLTMETER) IS DC VOLTAGE (NO INPUT SIGNAL).
 - ALL PNP TRANSISTORS ARE EQUIVALENT TO 2SA1015-GR UNLESS OTHERWISE NOTED.
 - ALL NPN TRANSISTORS ARE EQUIVALENT TO 2SC1815-GR UNLESS OTHERWISE NOTED.
 - ALL DIODES ARE EQUIVALENT TO 1SS133 UNLESS OTHERWISE NOTED.
 - ELECTROLYTIC CAPACITORS () ARE IN uF/WV.
 - ALL CAPACITORS ARE IN pF/50WV UNLESS OTHERWISE NOTED.
 - EX) 005: 3pF, 330: 33k, 331: 330pF, 333: 0.033uF.
 - ALL RESISTORS ARE IN OHMS 1/8 WATT UNLESS OTHERWISE NOTED.
 - THE THICK LINES ON PC BOARD ARE THE PRINTING SIDE OF THE PARTS.
 - EX) PRINTING SIDE
 - *NM* AND *NC* ARE SHORT FOR "NOT MOUNTED" AND "NOT CONNECTED", WHICH MEANS NO PART IS MOUNTED OR WIRING PATTERN OF PCB.
 - CIRCUIT IS SUBJECT TO CHANGE FOR IMPROVEMENT.

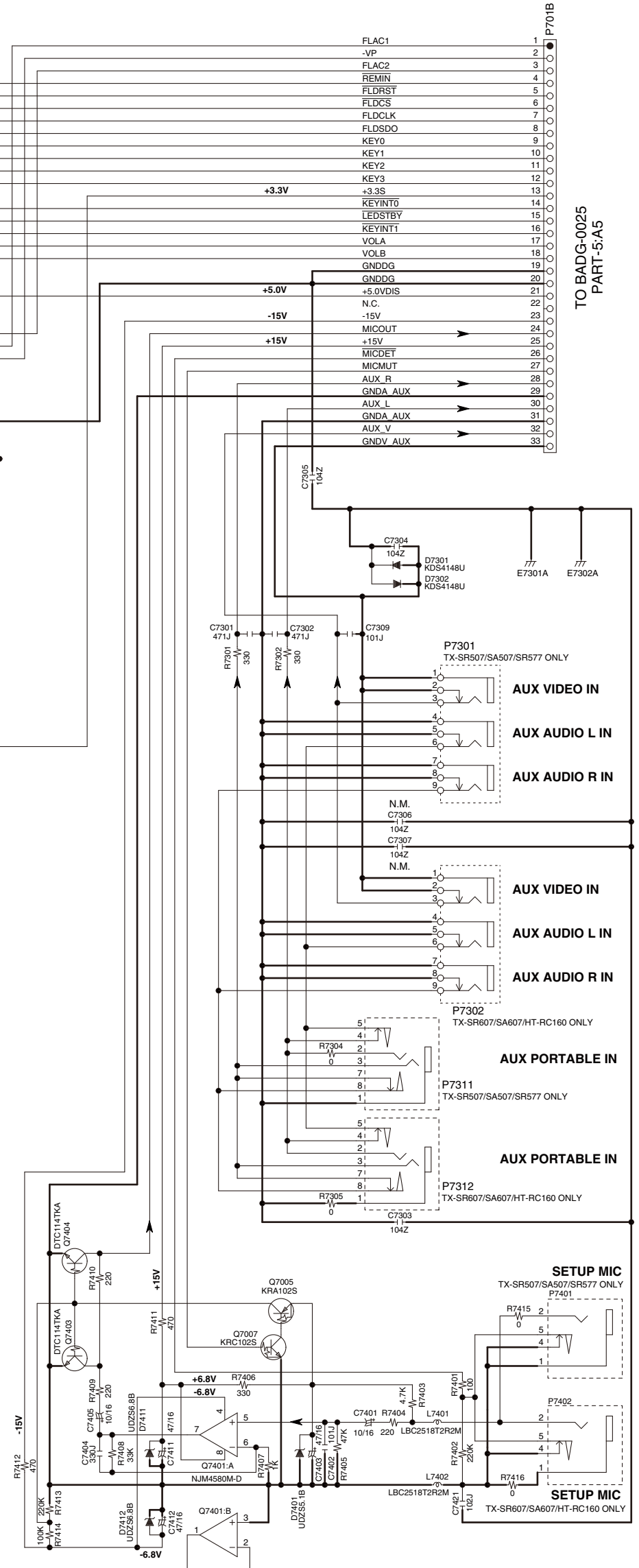

TO BADG-0025
PART-5A5

TX-SR607/SA607/HT-RC160 ONLY

TX-SR607/SA607/HT-RC160 ONLY

TX-SR607/SA607/HT-RC160 ONLY

TX-SR607/SA607/HT-RC160 ONLY

SCHEMATIC DIAGRAMS-9 / PART-11
HDMI SECTION

NOTE:
PART-10 and PART-12 are not used for TX-SR507/TX-SA507/TX-SR577.
PART-12 are not used for DTR-20.1.

NOTE:
XY in "SCHEMATIC-a / PART-b:XY" indicates the target location of the plug or socket, X=A to E/H/K, Y=1 to 4/5/8.

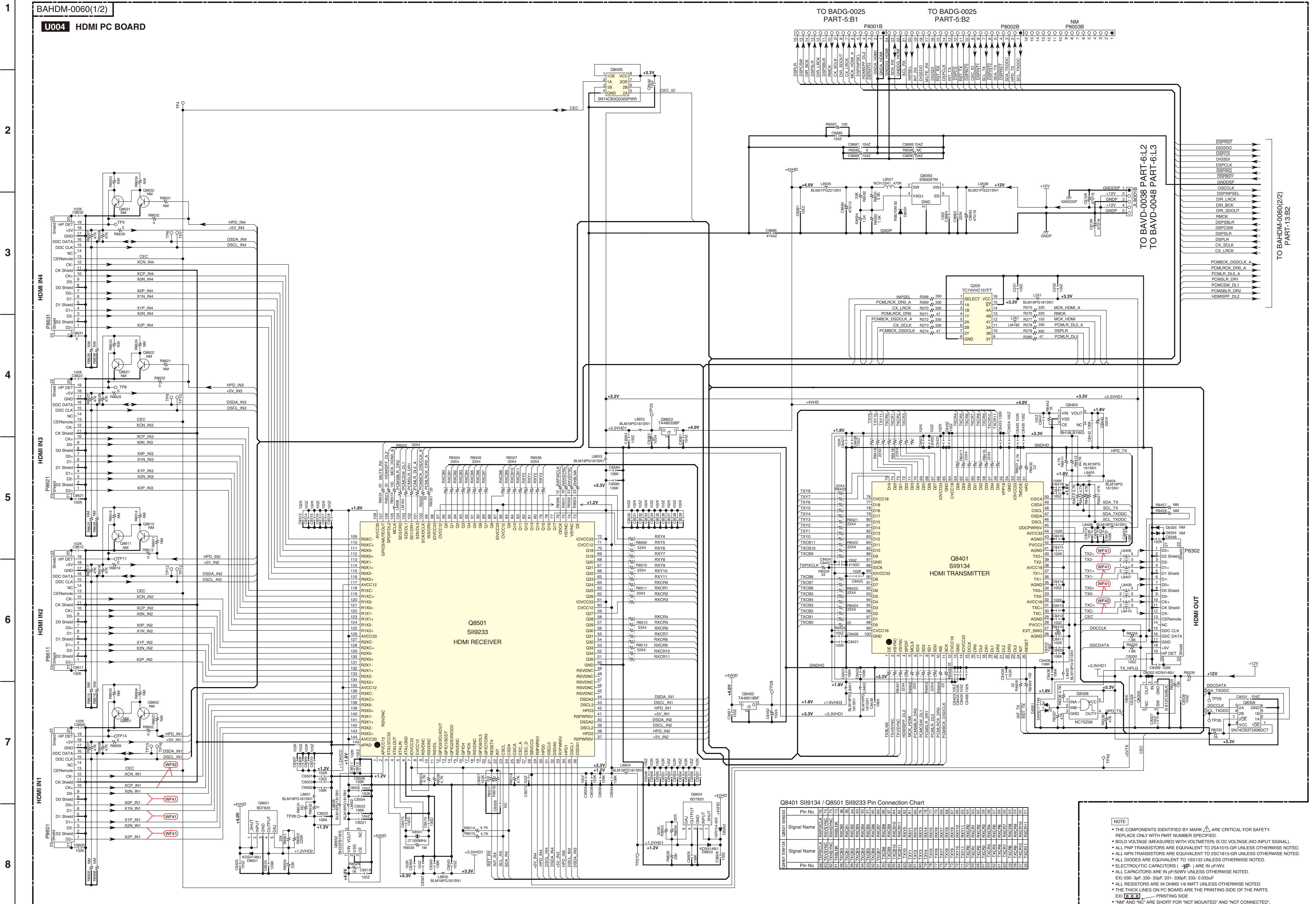

Q8401 SI19134 / Q8501 SI19233 Pin Connection Chart

Signal Name	Pin No.	Signal Name	Pin No.
SDA_TXDDCK	1	TXD0	1
SDA_TXDDC	2	TXD1	2
SDA_TXDDA	3	TXD2	3
SDA_TXDD	4	TXD3	4
SDA_TXD	5	TXD4	5
SDA_TX	6	TXD5	6
SDA	7	TXD6	7
TXD0	8	TXD7	8
TXD1	9	TXD8	9
TXD2	10	TXD9	10
TXD3	11	TXD10	11
TXD4	12	TXD11	12
TXD5	13	TXD12	13
TXD6	14	TXD13	14
TXD7	15	TXD14	15
TXD8	16	TXD15	16
TXD9	17	TXD16	17
TXD10	18	TXD17	18
TXD11	19	TXD18	19
TXD12	20	TXD19	20
TXD13	21	TXD20	21
TXD14	22	TXD21	22
TXD15	23	TXD22	23
TXD16	24	TXD23	24
TXD17	25	TXD24	25
TXD18	26	TXD25	26
TXD19	27	TXD26	27
TXD20	28	TXD27	28
TXD21	29	TXD28	29
TXD22	30	TXD29	30
TXD23	31	TXD30	31
TXD24	32	TXD31	32
TXD25	33	TXD32	33
TXD26	34	TXD33	34
TXD27	35	TXD34	35
TXD28	36	TXD35	36
TXD29	37	TXD36	37
TXD30	38	TXD37	38
TXD31	39	TXD38	39
TXD32	40	TXD39	40
TXD33	41	TXD40	41
TXD34	42	TXD41	42
TXD35	43	TXD42	43
TXD36	44	TXD43	44
TXD37	45	TXD44	45
TXD38	46	TXD45	46
TXD39	47	TXD46	47
TXD40	48	TXD47	48
TXD41	49	TXD48	49
TXD42	50	TXD49	50
TXD43	51	TXD50	51
TXD44	52	TXD51	52
TXD45	53	TXD52	53
TXD46	54	TXD53	54
TXD47	55	TXD54	55
TXD48	56	TXD55	56
TXD49	57	TXD56	57
TXD50	58	TXD57	58
TXD51	59	TXD58	59
TXD52	60	TXD59	60
TXD53	61	TXD60	61
TXD54	62	TXD61	62
TXD55	63	TXD62	63
TXD56	64	TXD63	64
TXD57	65	TXD64	65
TXD58	66	TXD65	66
TXD59	67	TXD66	67
TXD60	68	TXD67	68
TXD61	69	TXD68	69
TXD62	70	TXD69	70
TXD63	71	TXD70	71
TXD64	72	TXD71	72
TXD65	73	TXD72	73
TXD66	74	TXD73	74
TXD67	75	TXD74	75
TXD68	76	TXD75	76
TXD69	77	TXD76	77
TXD70	78	TXD77	78
TXD71	79	TXD78	79
TXD72	80	TXD79	80
TXD73	81	TXD80	81
TXD74	82	TXD81	82
TXD75	83	TXD82	83
TXD76	84	TXD83	84
TXD77	85	TXD84	85
TXD78	86	TXD85	86
TXD79	87	TXD86	87
TXD80	88	TXD87	88
TXD81	89	TXD88	89
TXD82	90	TXD89	90
TXD83	91	TXD90	91
TXD84	92	TXD91	92
TXD85	93	TXD92	93
TXD86	94	TXD93	94
TXD87	95	TXD94	95
TXD88	96	TXD95	96
TXD89	97	TXD96	97
TXD90	98	TXD97	98
TXD91	99	TXD98	99
TXD92	100	TXD99	100

- NOTE
- THE COMPONENTS IDENTIFIED BY MARK Δ ARE CRITICAL FOR SAFETY. REPLACE ONLY WITH PART NUMBER SPECIFIED.
 - BOLD VOLTAGE (MEASURED WITH VOLTMETER) IS DC VOLTAGE (NO INPUT SIGNAL).
 - ALL PNP TRANSISTORS ARE EQUIVALENT TO 2SA1015-GR UNLESS OTHERWISE NOTED.
 - ALL NPN TRANSISTORS ARE EQUIVALENT TO 2SC1815-GR UNLESS OTHERWISE NOTED.
 - ALL DIODES ARE EQUIVALENT TO 1SS135 UNLESS OTHERWISE NOTED.
 - ELECTROLYTIC CAPACITORS (---) ARE IN μF .
 - ALL CAPACITORS ARE IN pF UNLESS OTHERWISE NOTED.
 - EX: 030-3pF, 330-33pF, 333-0.033 μF
 - ALL RESISTORS ARE IN OHMS UNLESS OTHERWISE NOTED.
 - THE THICK LINES ON PCB BOARD ARE THE PRINTING SIDE OF THE PARTS.
 - EX: \square \square \square PRINTING SIDE
 - "NM" AND "NC" ARE SHORT FOR "NOT MOUNTED" AND "NOT CONNECTED", WHICH MEANS NO PART IS MOUNTED ON WIRING PATTERN OF PCB.
 - CIRCUIT IS SUBJECT TO CHANGE FOR IMPROVEMENT.

Notes:
Refer to SCHEMATIC DIAGRAM-19 / PART-17 for HDMI signal waveforms.

SCHEMATIC DIAGRAMS-11 / PART-13
DSP SECTION

NOTE:
PART-12, PART-14, PART-16 and PART-17 are not used for TX-SR507/TX-SA507/TX-SR577.
PART-12 is not used for DTR-20.1
PART-15 is used only for TX-SA507.

NOTE:
XY in "SCHEMATIC-a / PART-b:XY" indicates the target location of the plug or socket, X=A to E/H/K, Y=1 to 4/5/8.

1

2

3

4

5

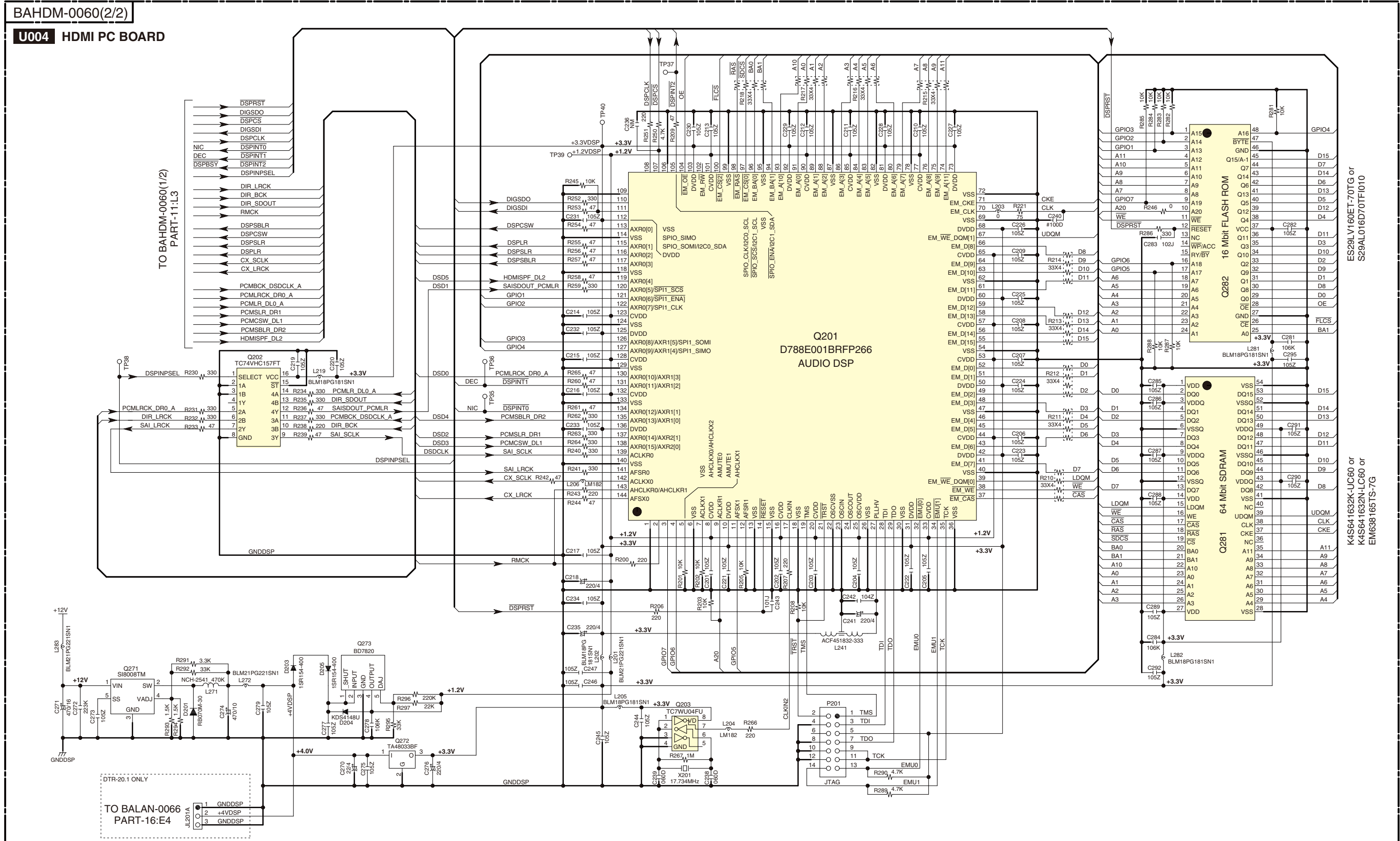

DTR-20.1 ONLY

TO BALAN-0066 PART-16:E4

1 GND DSP
2 +4V DSP
3 GND DSP

ES29LV160ET-70TG or S29AL016D70TF010

K4S641632K-UC60 or K4S641632N-LC60 or EM638165TS-7G

A **B** **C** **D** **E**

SCHEMATIC DIAGRAMS-16 / PART-18
PWOER SUPPLY SECTION

NOTE:
SCHEMATIC-12/PART-14 is not used for TX-SR507/TX-SA507/TX-SR577.
SCHEMATIC-13/PART-15 is used only for TX-SA607/TX-SA507.
SCHEMATIC-14/PART-16 and SCHEMATIC-15/PART-17 are not used for TX-SR607/TX-SA607/TX-SR507/TX-SR577/TX-SA507/TX-SR577.

NOTE:
XY in "SCHEMATIC-a / PART-b:XY" indicates the target location of the plug or socket, X=A to E/H/K, Y=1 to 4/5/8.

NOTE

- THE COMPONENTS IDENTIFIED BY MARK ARE CRITICAL FOR SAFETY. REPLACE ONLY WITH PART NUMBER SPECIFIED.
- VOLTAGE (MEASURED WITH VOLTMETER) IS DC VOLTAGE (NO INPUT SIGNAL).
- ELECTROLYTIC CAPACITORS () ARE IN uF/WV.
- ALL CAPACITORS ARE IN pF/50WV UNLESS OTHERWISE NOTED.
EX) 030- 3pF 330- 33pF 331- 330pF 333- 0.033uF
- CIRCUIT IS SUBJECT TO CHANGE FOR IMPROVEMENT.

CAUTION



FOR CONTINUED PROTECTION AGAINST FIRE HAZARD, REPLACE ONLY WITH FUSE OF SAME TYPE AND RATING INDICATED.

ATTENTION



AFIN D'ASSURER UNE PROTECTION PERMANENTE CONTRE LES RISQUES D'INCENDIE, REMPLACER UNIQUEMENT PAR UN FUSIBLE DE MEME TYPE ET CALIBRATION COMME INDIQUE.

BAETC-0041

U0035 INLET PC BOARD



POWER SUPPLY

TYPE	VOLTAGE/FREQ.
DD DC DF	120V / 60HZ
PR PB PA MO MR MQ	230-240V / 50HZ
JJ	100V / 50/60HZ

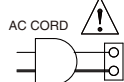

T902

TYPE	TX-SR507, TX-SR577 TX-SR607, HT-RC160 HT-R670	TX-SA507 TX-SA607
DD DC DF	NPT-1520JQ	---
PP PB PA MO MR MQ	NPT-1520GQ	---
JJ	---	NPT-1520JQ

T901

TYPE	TX-SR507, TX-SR577 TX-SA507, HT-R670	TX-SR607 TX-SA607	HT-R160
DD DC DF	NPT-1516D	NPT-1552D	10A 125V
PA MO MR MQ	NPT-1516DQ	NPT-1552DQ	---
PB PP	NPT-1516P	NPT-1552P	---
JJ	NPT-1516J	NPT-1552J	---

F901

TYPE	TX-SR507, TX-SR577 HT-R670	TX-SR607	TX-SA507	TX-SA607	HT-R160
DD DC DF	8A 125V	10A 125V	---	---	10A 125V
PP PB PA MO MR MQ	T4AL250V	T5AL250V	---	---	---
JJ	---	---	10A 125V	12A 125V	---



THIS SYMBOL LOCATED NEAR THE FUSE INDICATES THAT THE FUSE USED IS SLOW OPERATING TYPE FOR CONTINUED PROTECTION AGAINST FIRE FUSE HAZARD, REPLACE WITH SAME TYPE FUSE. FOR FUSE RATING REFER TO THE MAKING ADJACENT TO THE SYMBOL.



CE SYMBOLE INDIQUE QUE LE FUSIBLE UTILISE EST A LENT, E POUR UNE PROTECTION PERMANENTE, N'UTILISER QUE DES FUSIBLES DE MEME TYPE. CE DARNIER EST INDIQUE LA QU LE PRESENT SYMBOLE EST APPOSE.

BAPS-0039

U0033 POWER SUPPLY PC BOARD

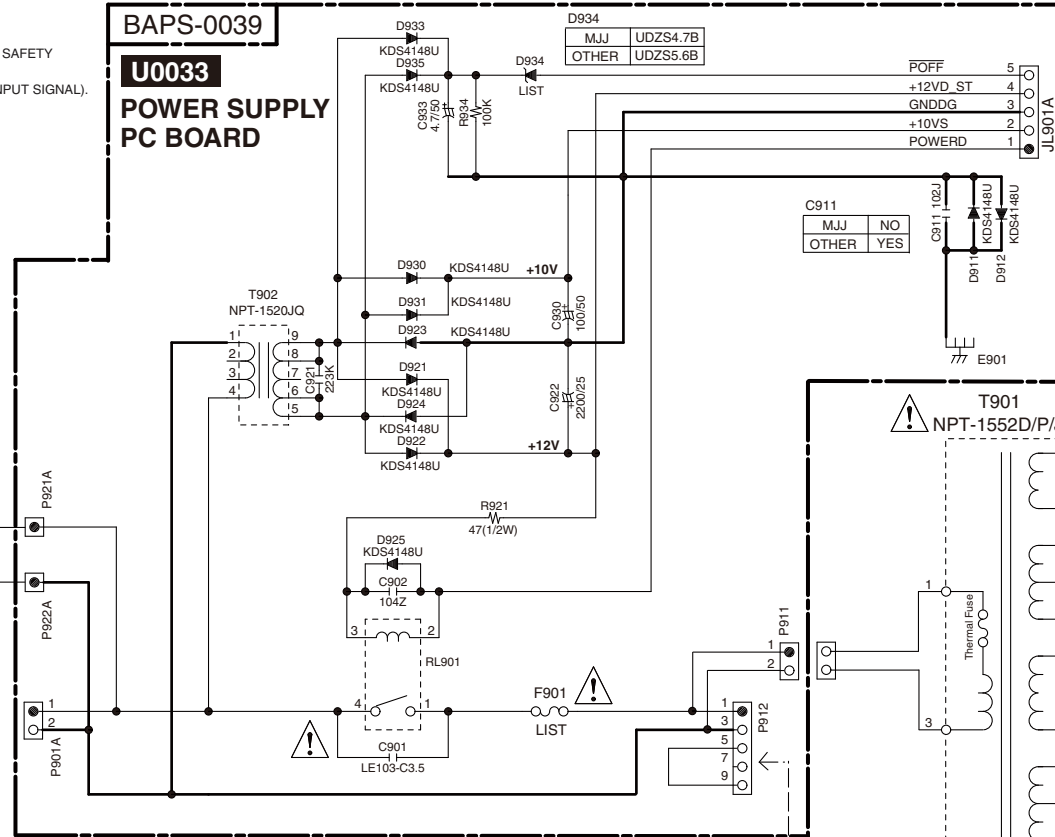

MJJ	NO
OTHER	YES

TO BADG-0025
PART-5:A2

	PWB	R951	F910
TXSR607/SA607/HT-RC160	BAPS-0016	NO	YES
TX-SR507/SA507/SR577	BAPS-0009	YES	NO

BAPS-0016

U0012 TRANS 2ND TERMINAL PC BOARD

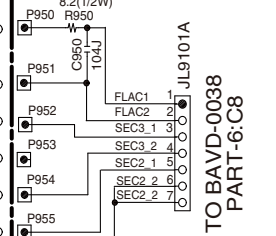

TO BAVD-0038
PART-6:C8

BAPS-0014

U0011 TRANS 2ND TERMINAL PC BOARD

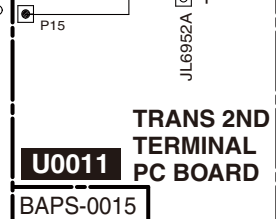

BAPS-0015

PWB	BAPS-0015
TX-SR607/TX-SA607	BAPS-0015
TX-SR507/SA507/SR577	BAPS-0010

T901 NPT-1516DQ

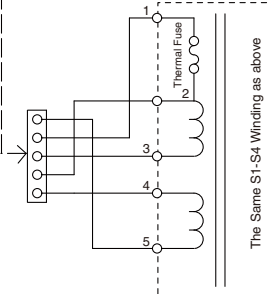

The Same S1-S4 Winding as above

1

2

3

4

SCHEMATIC DIAGRAMS-17 / PART-19
WAVEFORM SECTION

1

Digital Audio Waveform Part

NOTE:

1. (WF01) is short for (Waveform01)
2. Refer to SCHEMATIC DIAGRAM-3 / PART-5 for the location of each waveform in the circuit.
3. XY in "PART-b:XY" indicates each measurement point location, X=A to E/H/K, Y=1 to 4/5/8.

LR CLOCK (SAI_LRCK, CX_LRCK)
Fs=48kHz : DVD, Clock width=20.8us
Fs=44.1kHz : CD, Clock width=22.7us

BIT CLOCK (SAI_SLCK, CX_SLCK)
64Fs=3072kHz : DVD, Clock width=325ns
64Fs=2822.4kHz : CD, Clock width=354ns

(WF01) OPT1 (PART-5:C7)

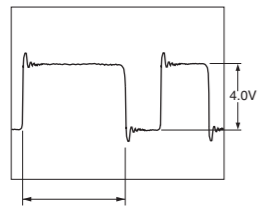

Duty varies according to audio data

(WF02) COAX1 (PART-5:B6,C7)

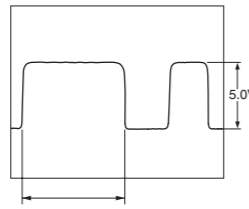

Duty always varies according to audio data

(WF03) SAI_SDOUT (PART-5:D7)

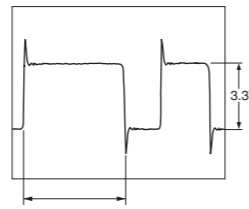

Duty varies according to audio data

(WF04) SAI_LRCK (PART-5:D7)

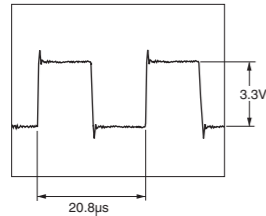

(WF05) SAI_SLCK (PART-5:D7)

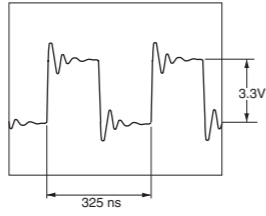

(WF06) DSPLR (PART-5:D7)

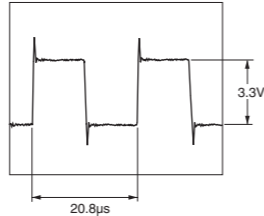

Front L/R audio data

(WF07) CX_LRCK (PART-5:D8)

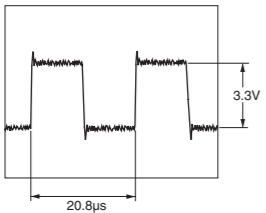

(WF08) CX_SLCK (PART-5:D8)

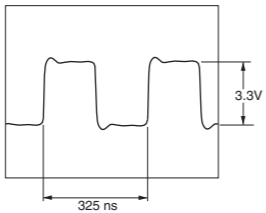

(WF09) FL+ (PART-5:F7)

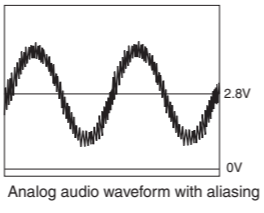

Analog audio waveform with aliasing noise

(WF10) DAC_FL (PART-5:G7)

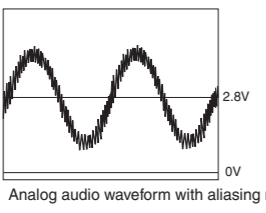

Analog audio waveform with aliasing noise

(WF10) DAC_FL (PART-5:G7)

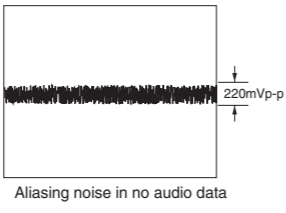

Aliasing noise in no audio data

2

3

4

5

Video source color and pattern

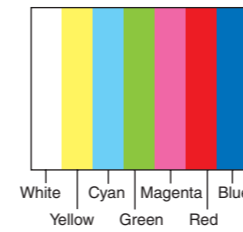

Composite waveform

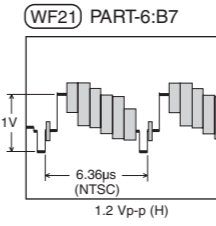

S-Video Y waveform

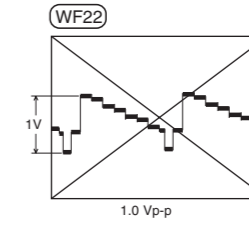

S-Video C waveform

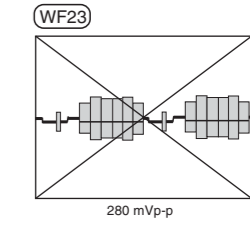

S-Video terminals are not installed for this model.

Component Y waveform

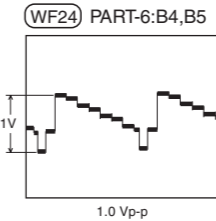

Component PB waveform

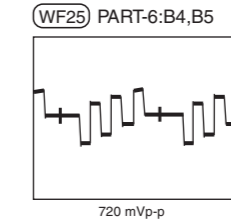

Component PR waveform

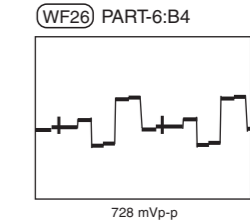

NOTE:

1. (WF21) is short for (Waveform21)
2. Refer to SCHEMATIC DIAGRAM-4/PART-6 for the location of each waveform on circuit.
3. XY in "PART-x:XY" indicates each socket's location, X=A to E/H/K, Y=1 to 4/5/8.
4. In the case that video outputs are not connected to video devices, video signal output levels are doubled.

HDMI Waveform Part

HDMI D0,D1,D2 waveform

(WF41) PART-11:B3, H4

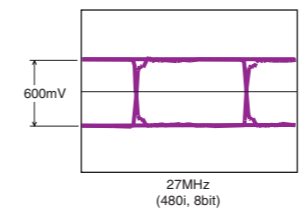
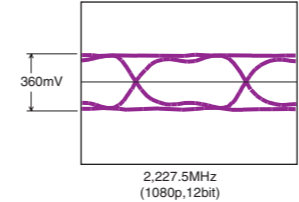

D0,D1,D2 Eye-pattern waveform, frequency and level vary according to video resolution, aspect and profile. Waveforms above are examples.

HDMI CK waveform

(WF42) PART-11:B3, H4

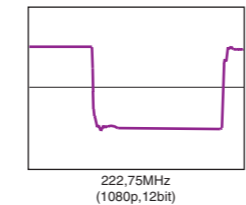

CK waveform, frequency and level differ according to video resolution, aspect and profile. D0,D1,D2 are just CK x10.

FL Driver IC Control Waveform Part

SCK/SDATA waveform

(WF61) PART-9:F4/D4

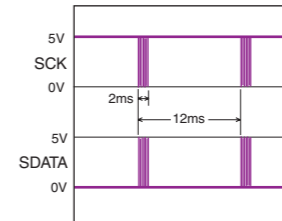

SCK/SDATA waveform

(WF61) PART-9:F4/D4

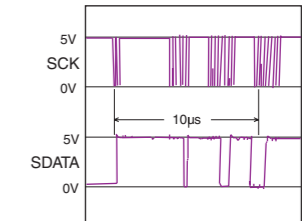

SDATA waveform varies according to the data content

SCK/CS waveform

(WF62) PART-9:F4/D4

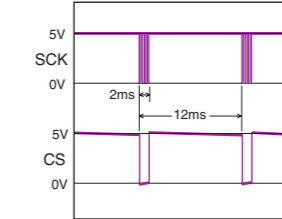

SCK/RESET waveform

(WF63) PART-9:F4/D4

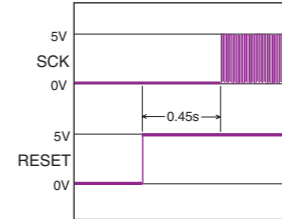

When power on

SCK/RESET waveform

(WF63) PART-9:F4/D4

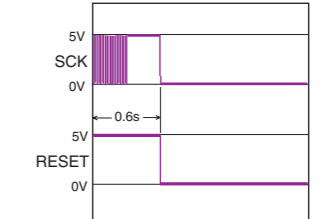

When power off

PRINTED CIRCUIT BOARD VIEWS-2 / U001

U001 INPUT SELECTOR / VOLUME / POWER AMP. PC BOARD
(BAAF-0008)

Component side

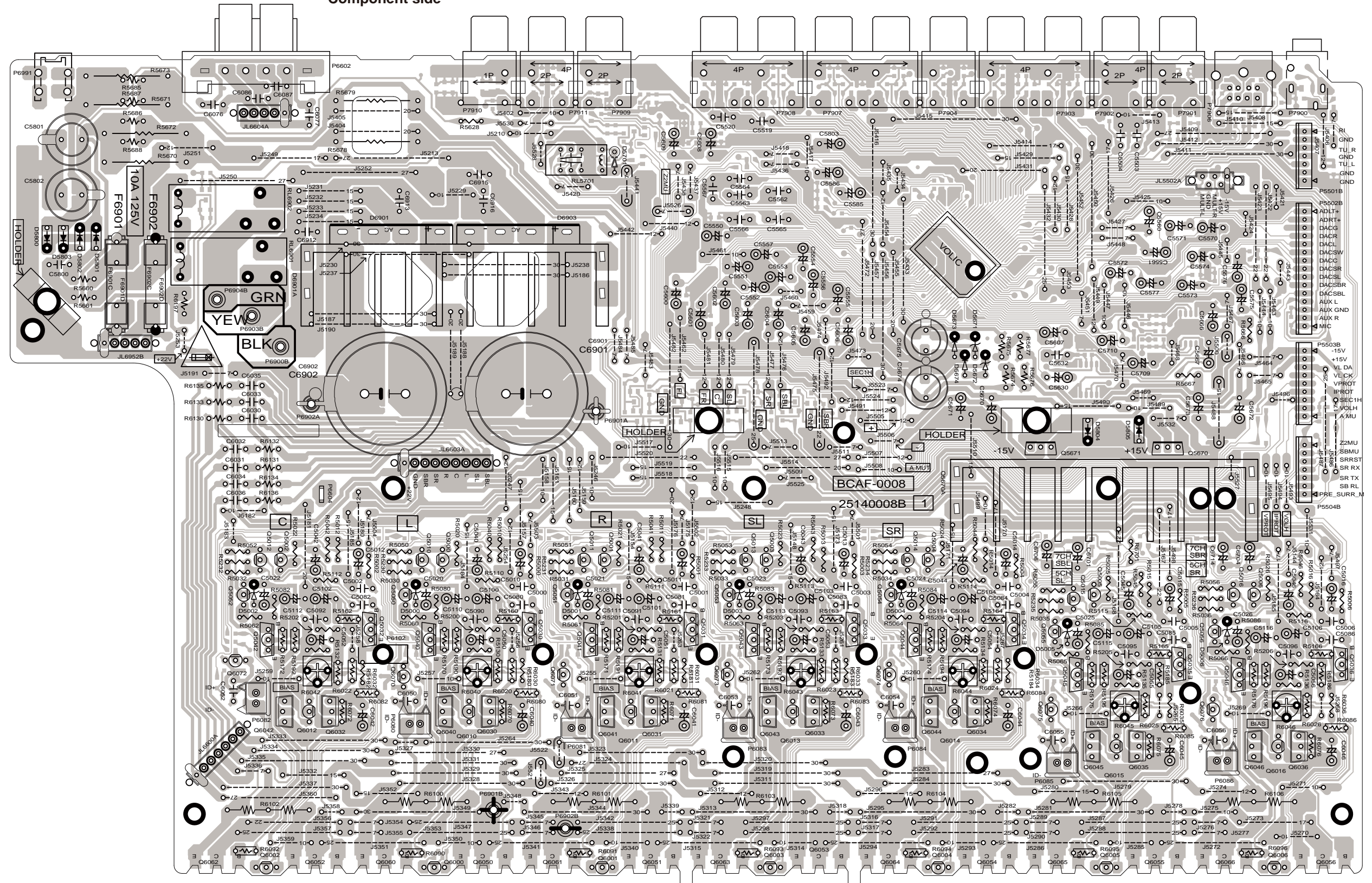

1

U0013 THERMAL SENSOR
(BAETC-0011)

Component side

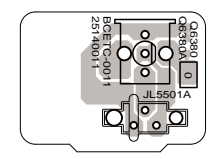

2

U0012 TRANS 2ND TERMINAL
(BAPS-0010)

Component side

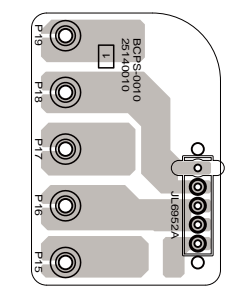

3

U0011 TRANS 2ND TERMINAL
(BAPS-0009)

Component side

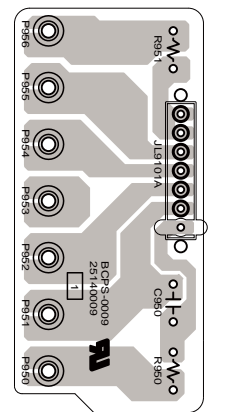

4

5

A B C D E F G H

PRINTED CIRCUIT BOARD VIEWS-3 / U001

U001 INPUT SELECTOR / VOLUME / POWER AMP. PC BOARD
(BAAF-0008)

Soldering side

1
2
3
4
5

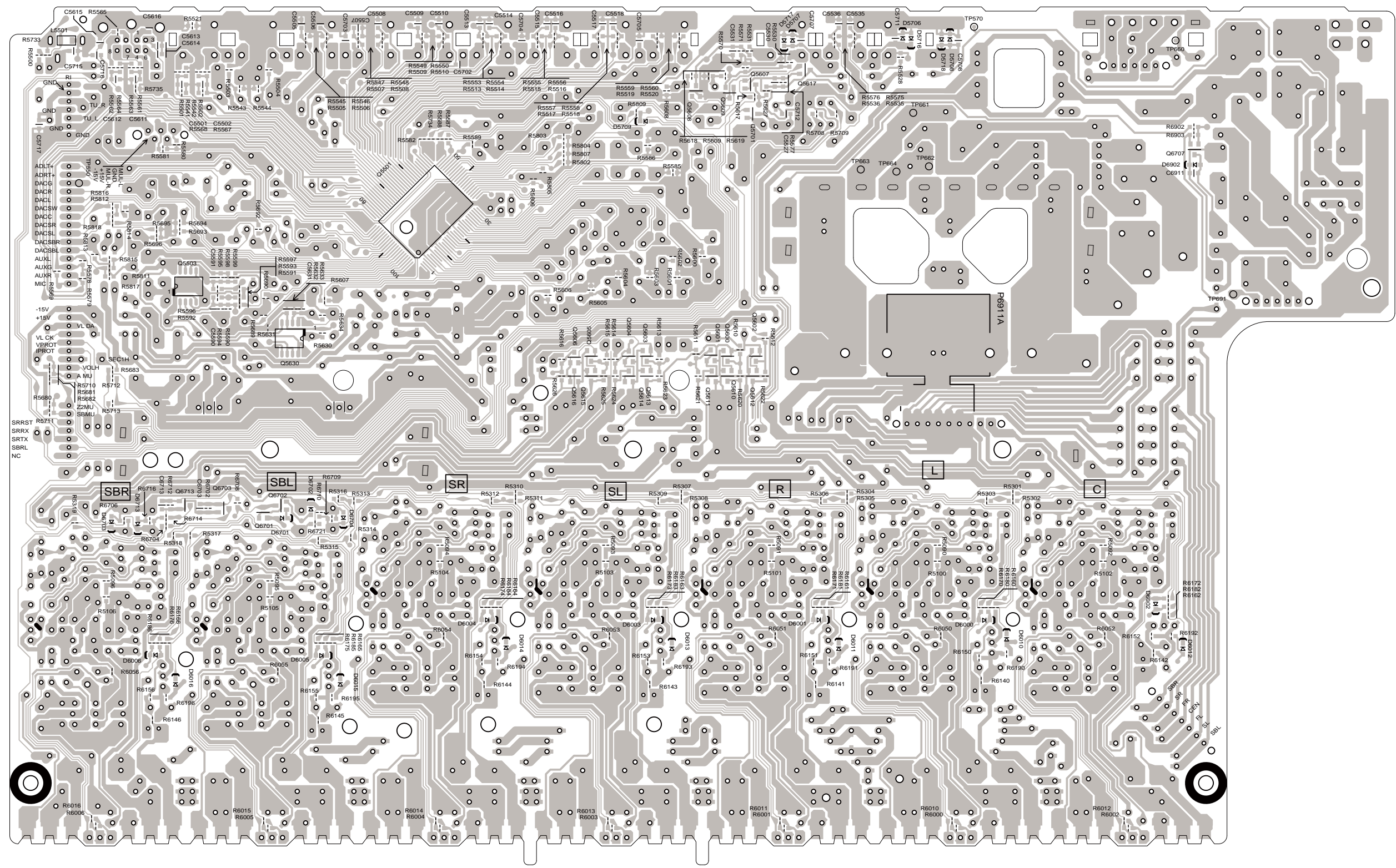

U0013 THERMAL SENSOR
(BAETC-0011)

Soldering side

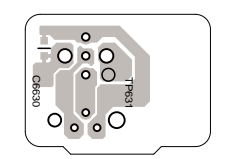

U0012 TRANS 2ND TERMINAL
(BAPS-0010)

Soldering side

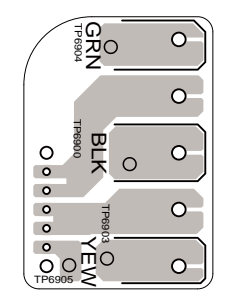

U0011 TRANS 2ND TERMINAL
(BAPS-0009)

Soldering side

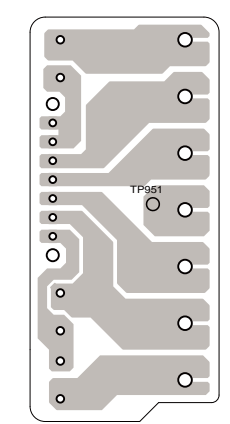

A B C D E F G H

PRINTED CIRCUIT BOARD VIEWS-5 / U002

U002 MPU / CODEC PC BOARD
(BADG-0025)

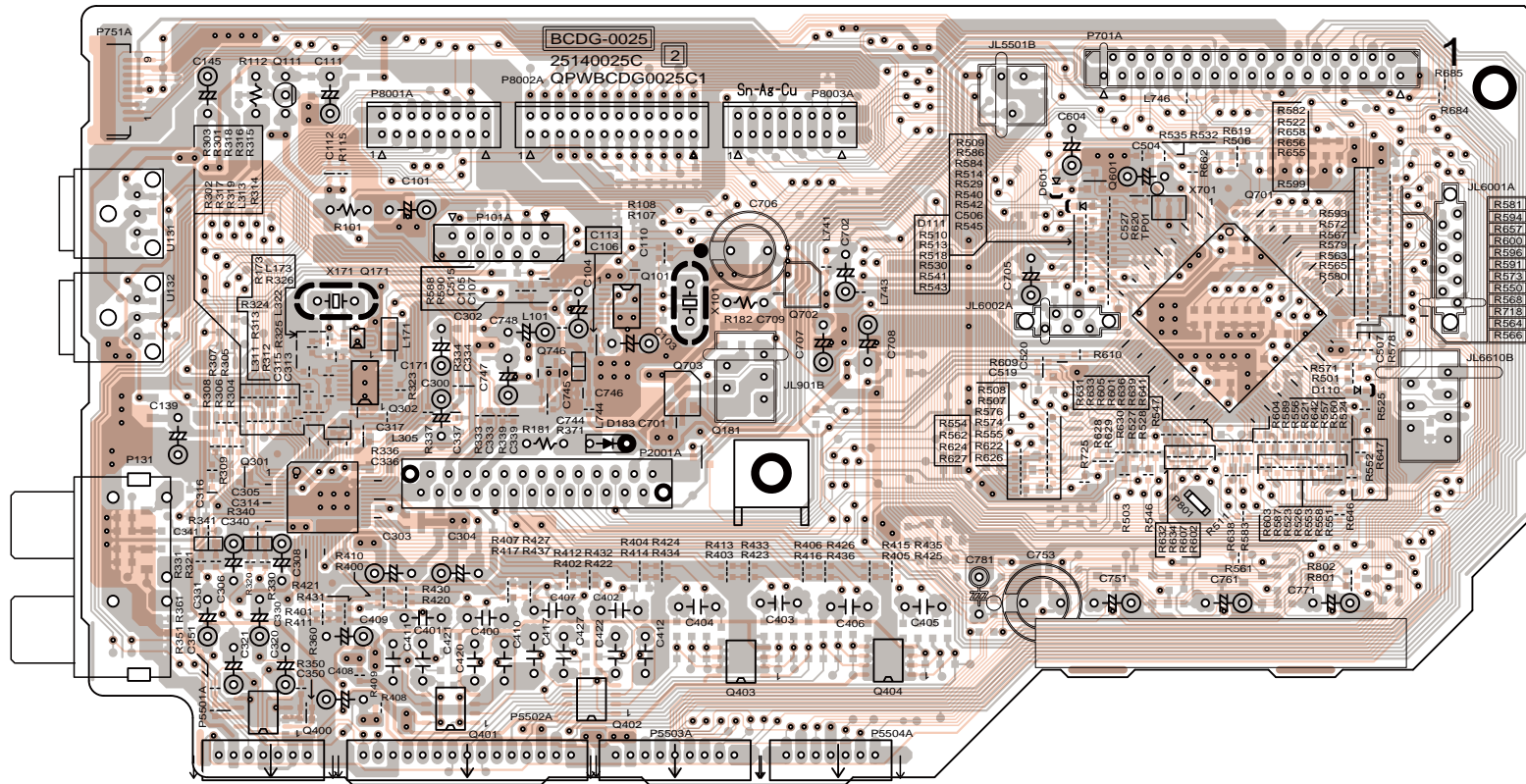

U002 MPU / CODEC PC BOARD
(BADG-0025)

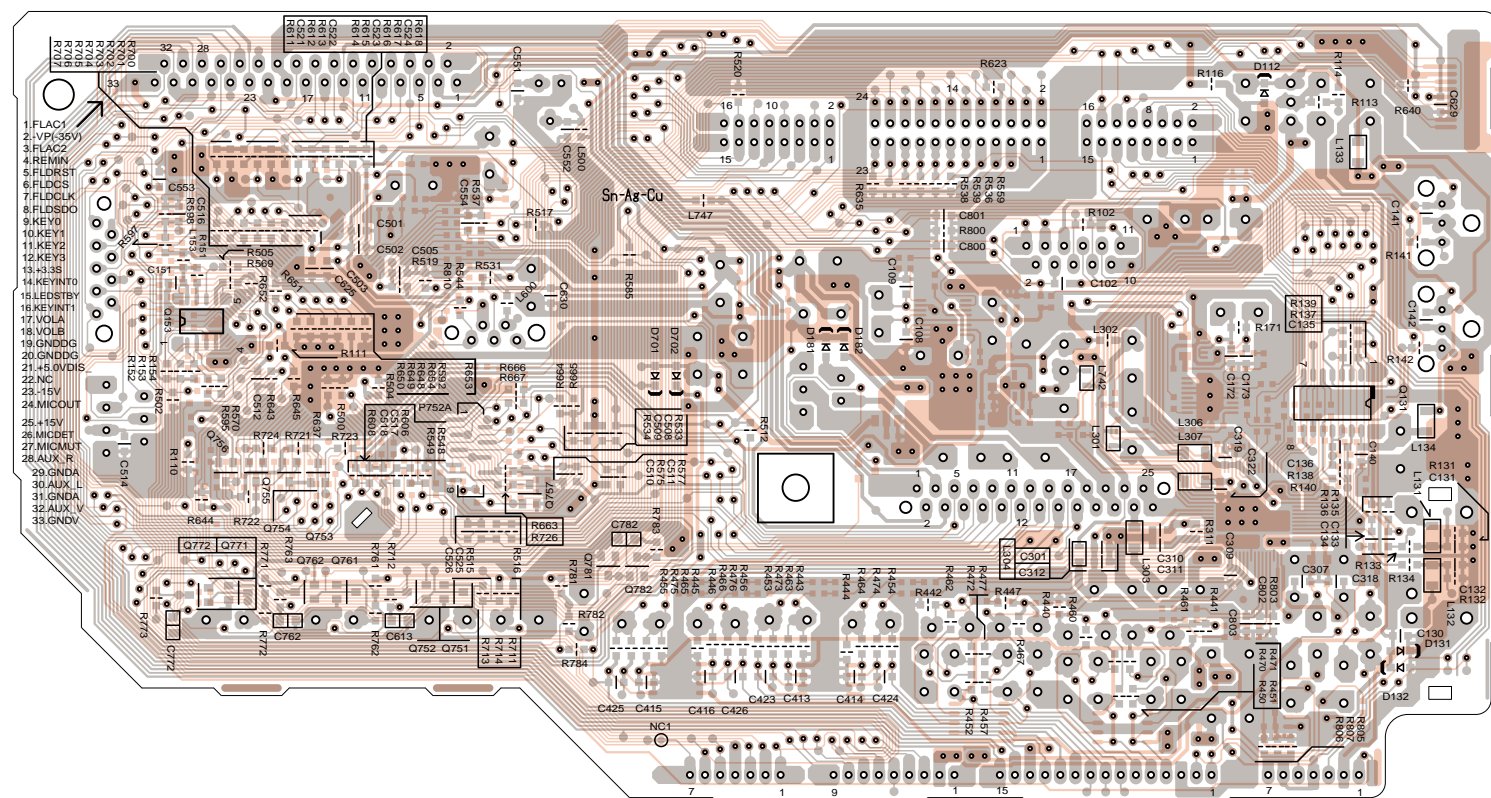

U0021 VLSC PC BOARD
(BADG-0026)
TX-SA607 only

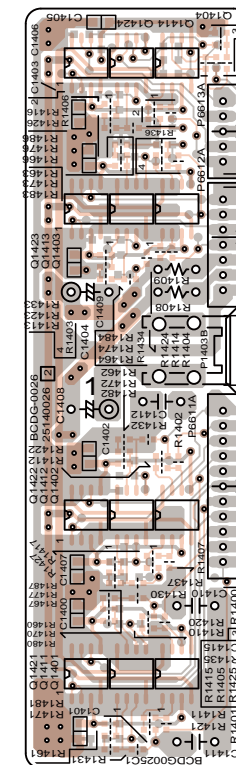

U0021 VLSC PC BOARD
(BADG-0026)
TX-SA607 only

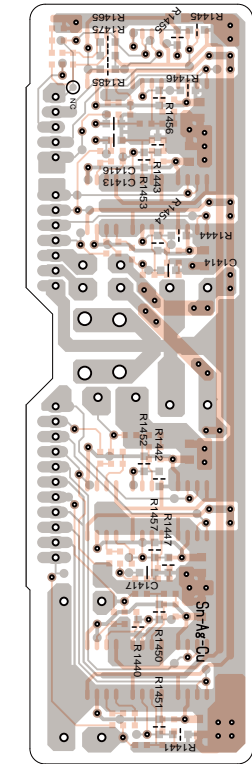

U0022 UNIVERSAL PORT PC BOARD
(BAETC-0027)

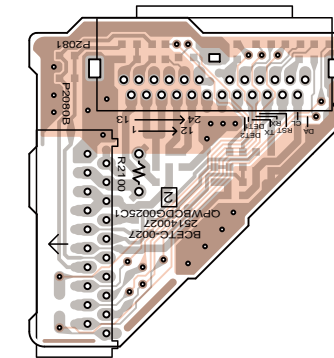

U0022 UNIVERSAL PORT PC BOARD
(BAETC-0027)

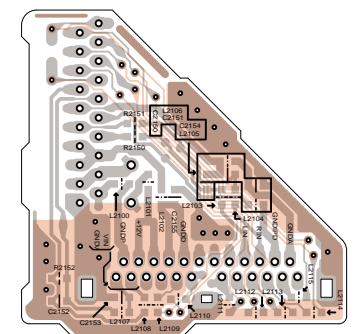

1

2

3

4

5

A B C D E F G H

PRINTED CIRCUIT BOARD VIEWS-7 / U003

U003 DISPLAY PC BOARD
(BADIS-0036)

Component side

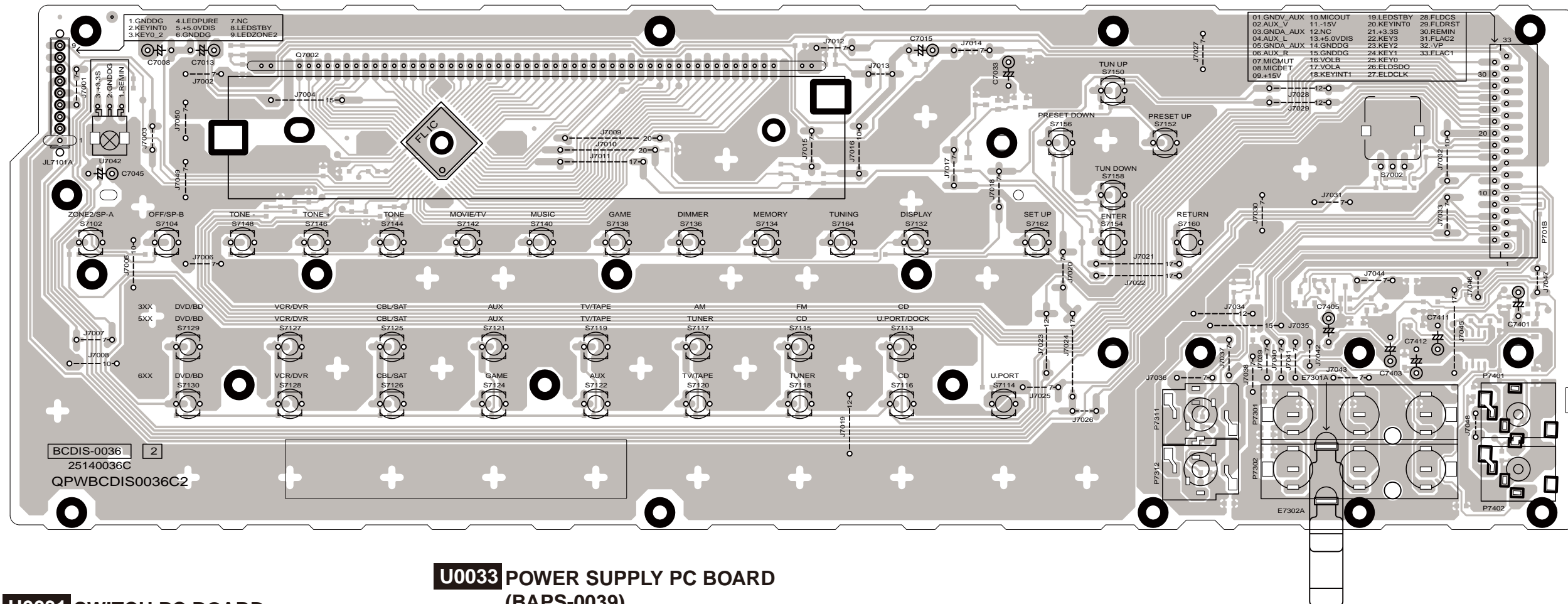

U0031 SWITCH PC BOARD
(BADIS-0037)

Component side

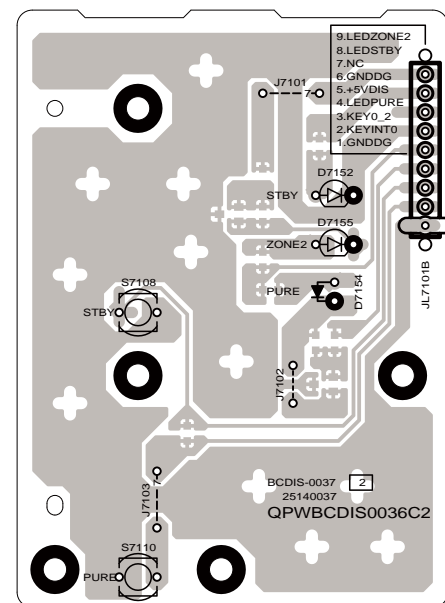

U0033 POWER SUPPLY PC BOARD
(BAPS-0039)

Component side

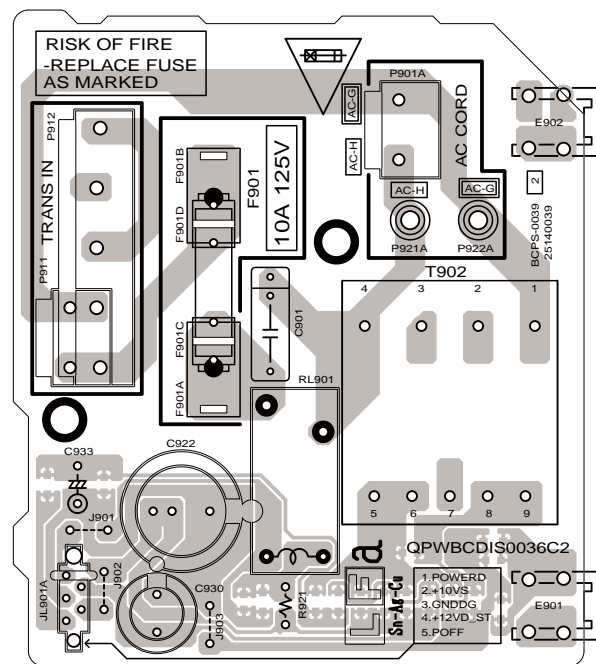

U0034 HEADPHONE PC BOARD
(BAETC-0040)

Component side

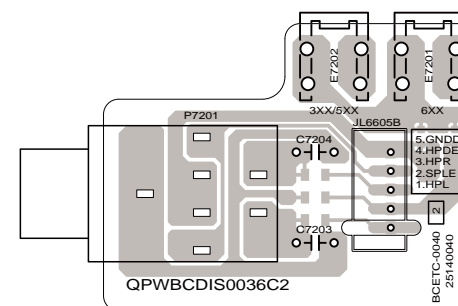

U0035 INLET PC BOARD
(BAETC-0041)

TX-SA507/607 and
TX-SR607<MR> only
Component side

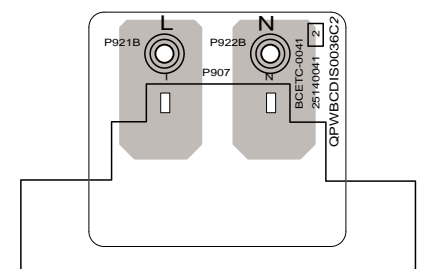

1

2

3

4

5

A B C D E F G H

PRINTED CIRCUIT BOARD VIEWS-8 / U003

U003 DISPLAY PC BOARD
(BADIS-0036)

Soldering side

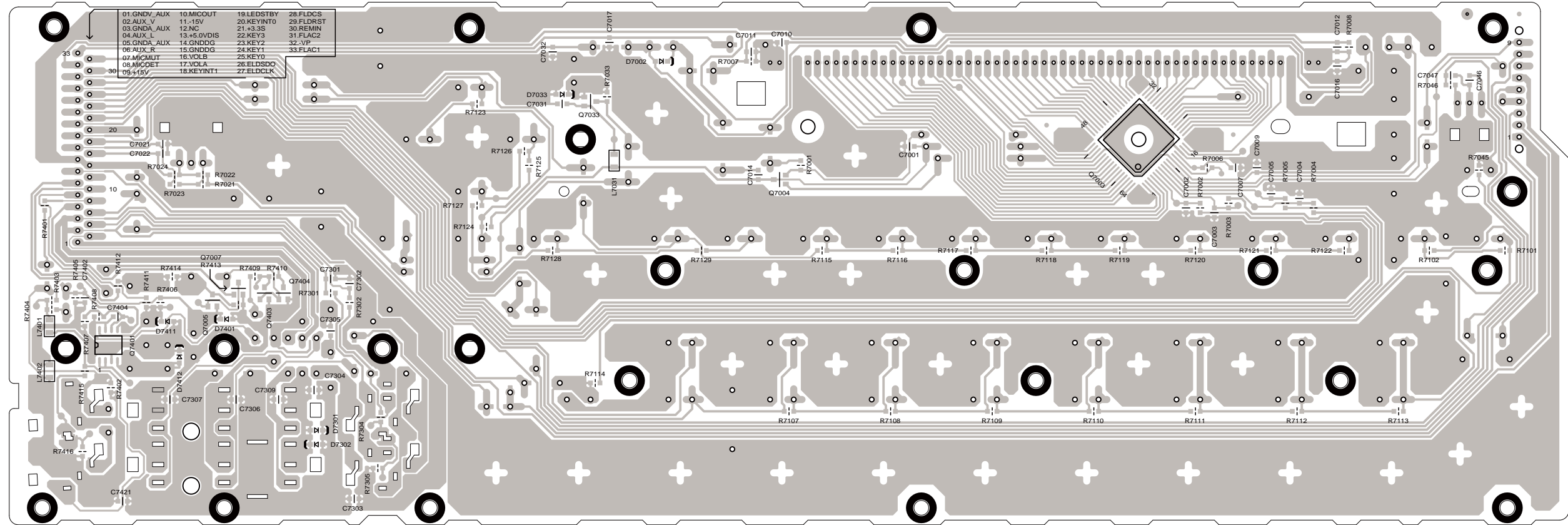

1

2

3

U0031 SWITCH PC BOARD
(BADIS-0037)

Soldering side

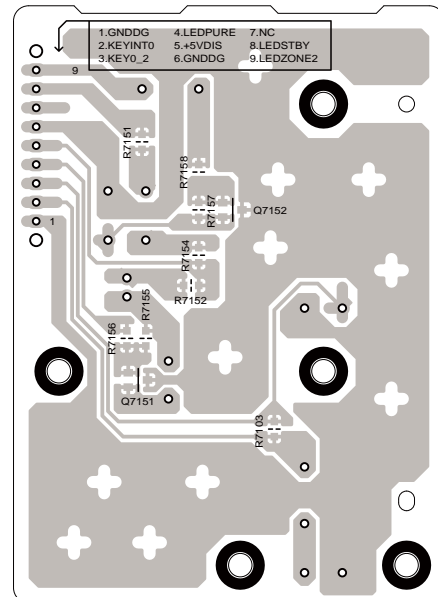

4

5

U0033 POWER SUPPLY PC BOARD
(BAPS-0039)

Soldering side

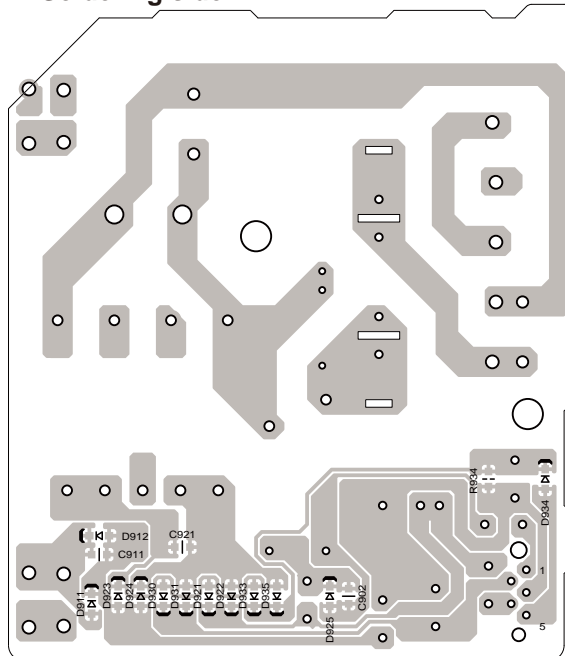

U0034 HEADPHONE PC BOARD
(BAETC-0040)

Soldering side

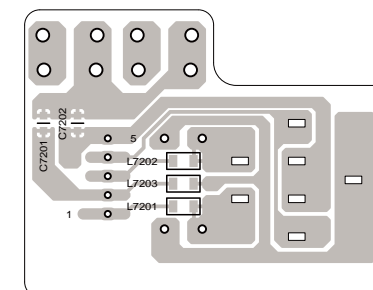

U0035 INLET PC BOARD
(BAETC-0041)

TX-SA507/607 and
TX-SR607<MR> only
Soldering side

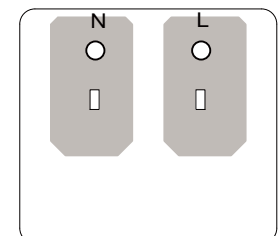

PRINTED CIRCUIT BOARD VIEWS-9 / U003

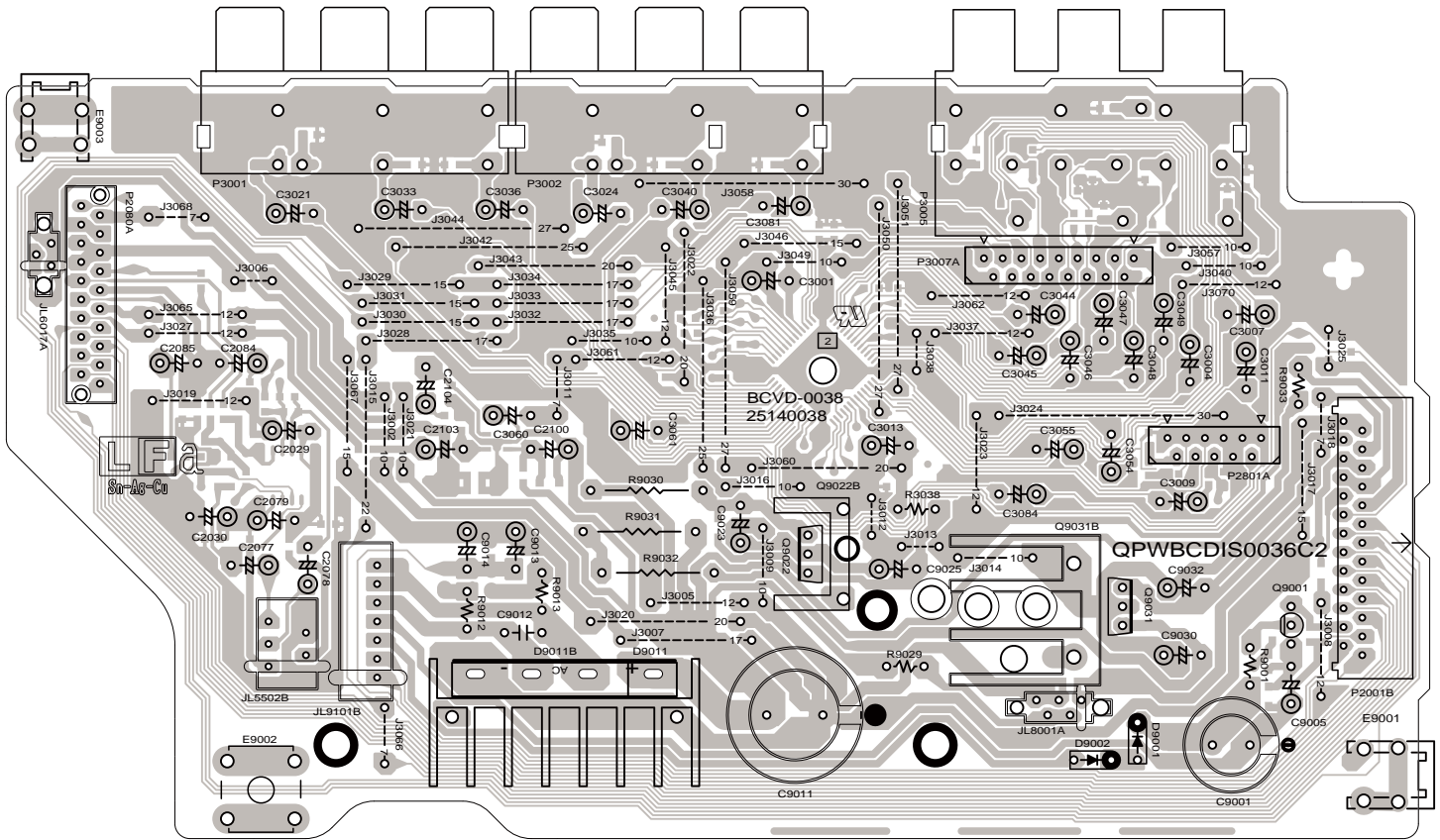
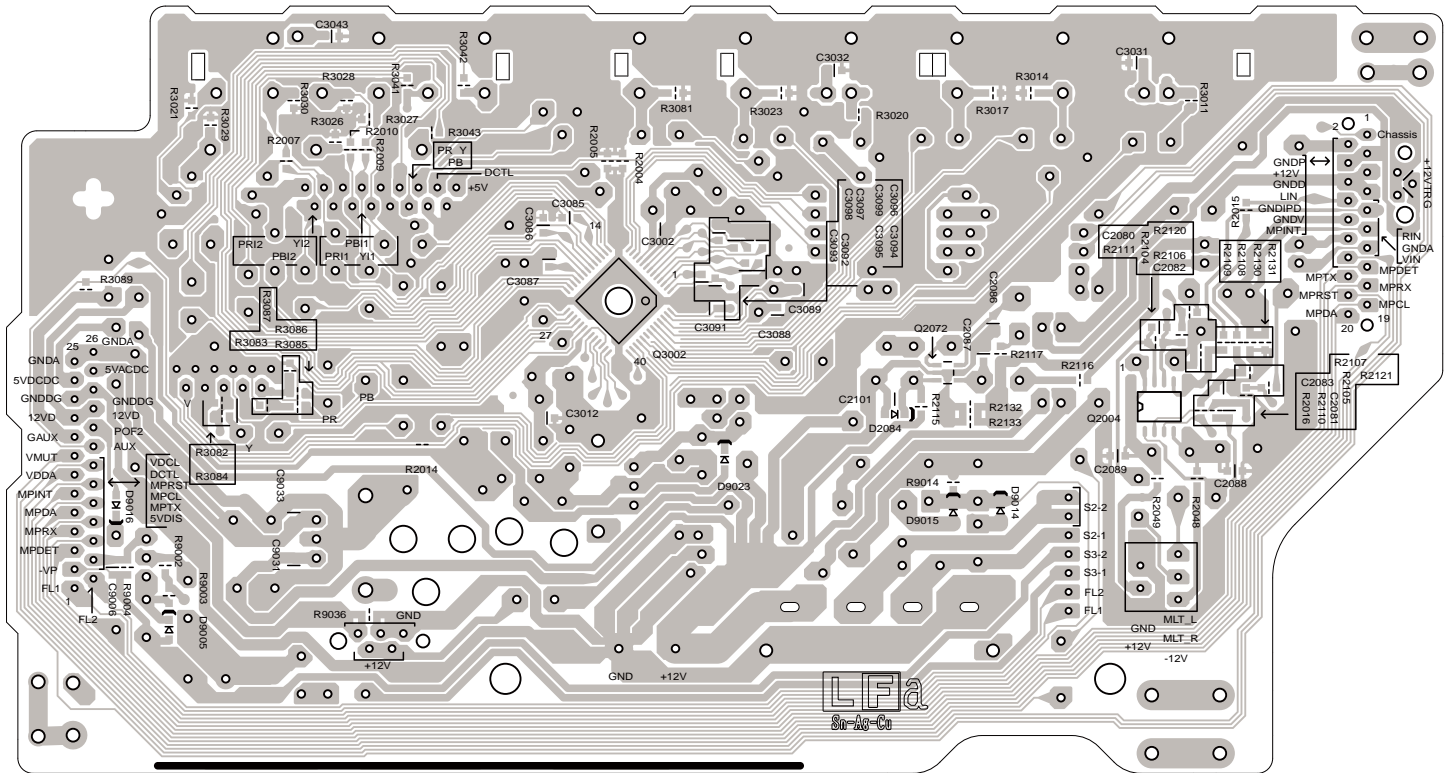
U0032 VIDEO PC BOARD
 (BAVD-0038) Component side

U0032 VIDEO PC BOARD
 (BAVD-0038) Soldering side

A

B

C

D

PRINTED CIRCUIT BOARD VIEWS-11 / U004

U004 HDMI / DSP PC BOARD
(BAHDM-0060)

1

2

3

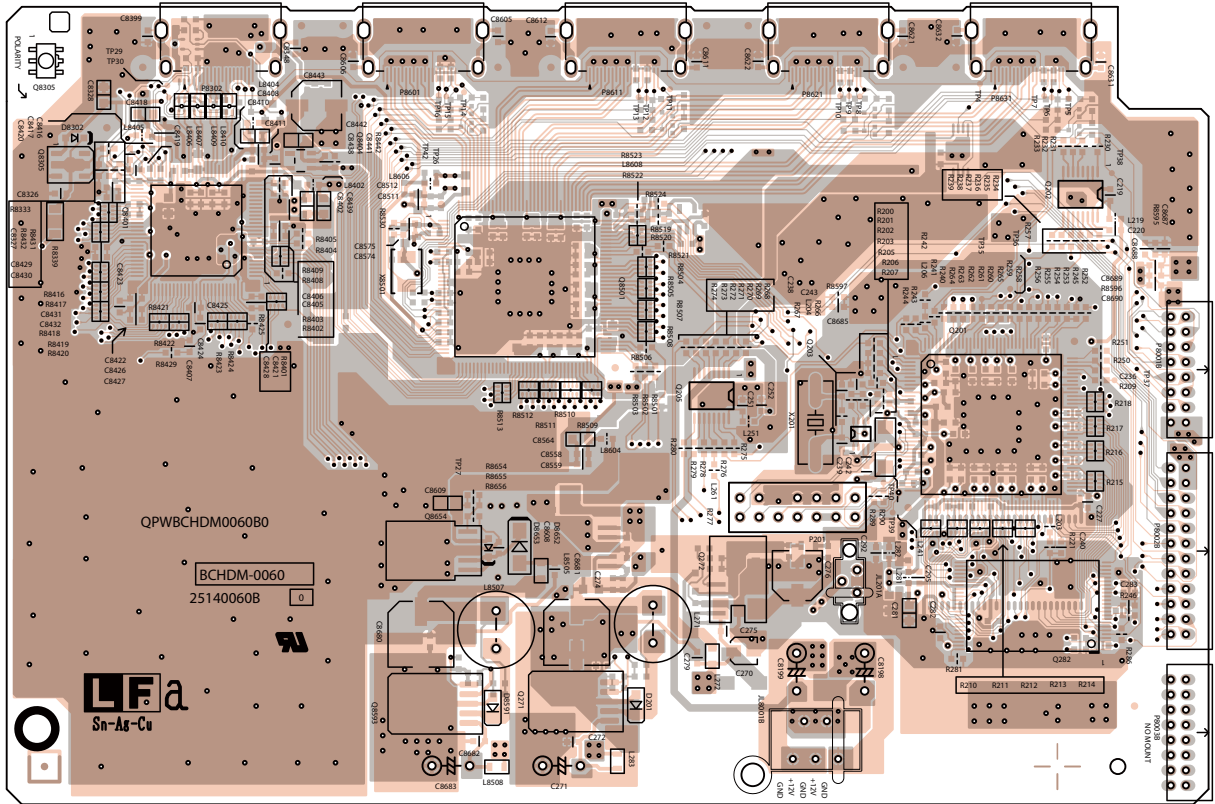

4

5

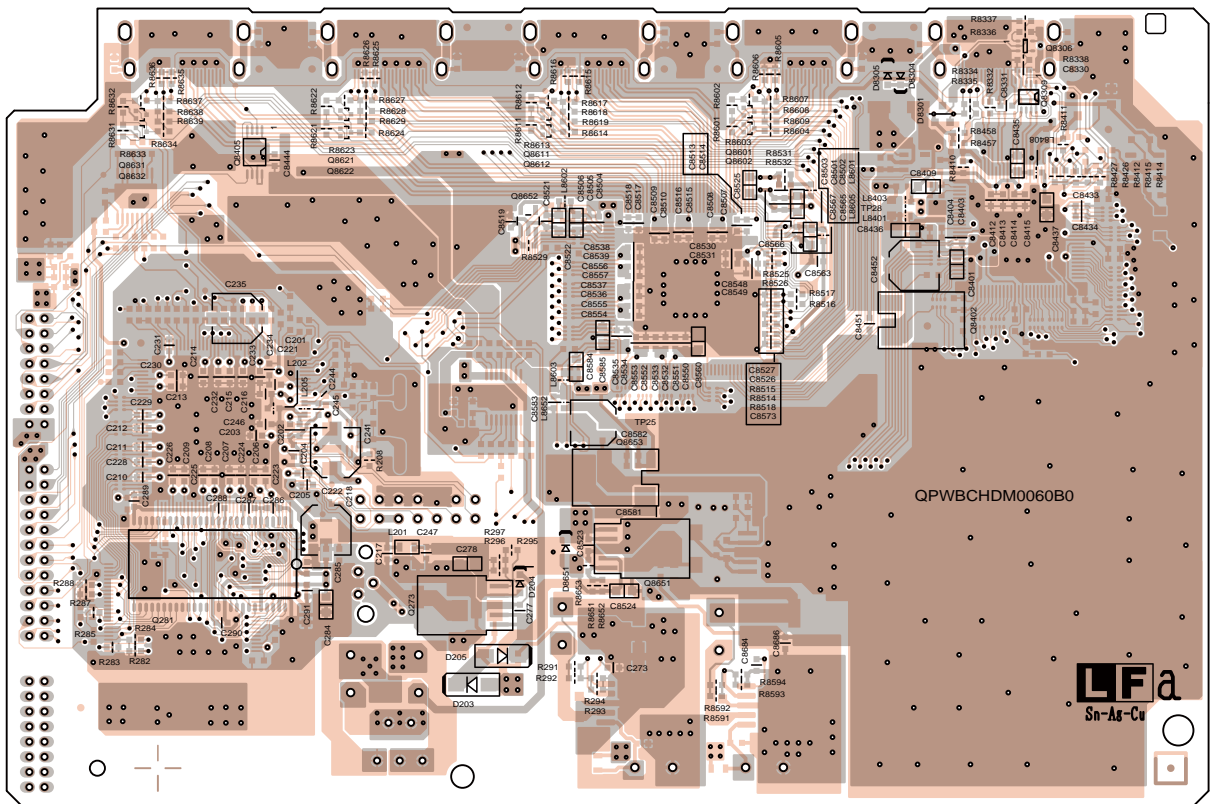

A B C D E F G H

PRINTED CIRCUIT BOARD VIEWS-13 / U005

U005 SP TERMINAL PC BOARD
(BATRM-0029)

Component side

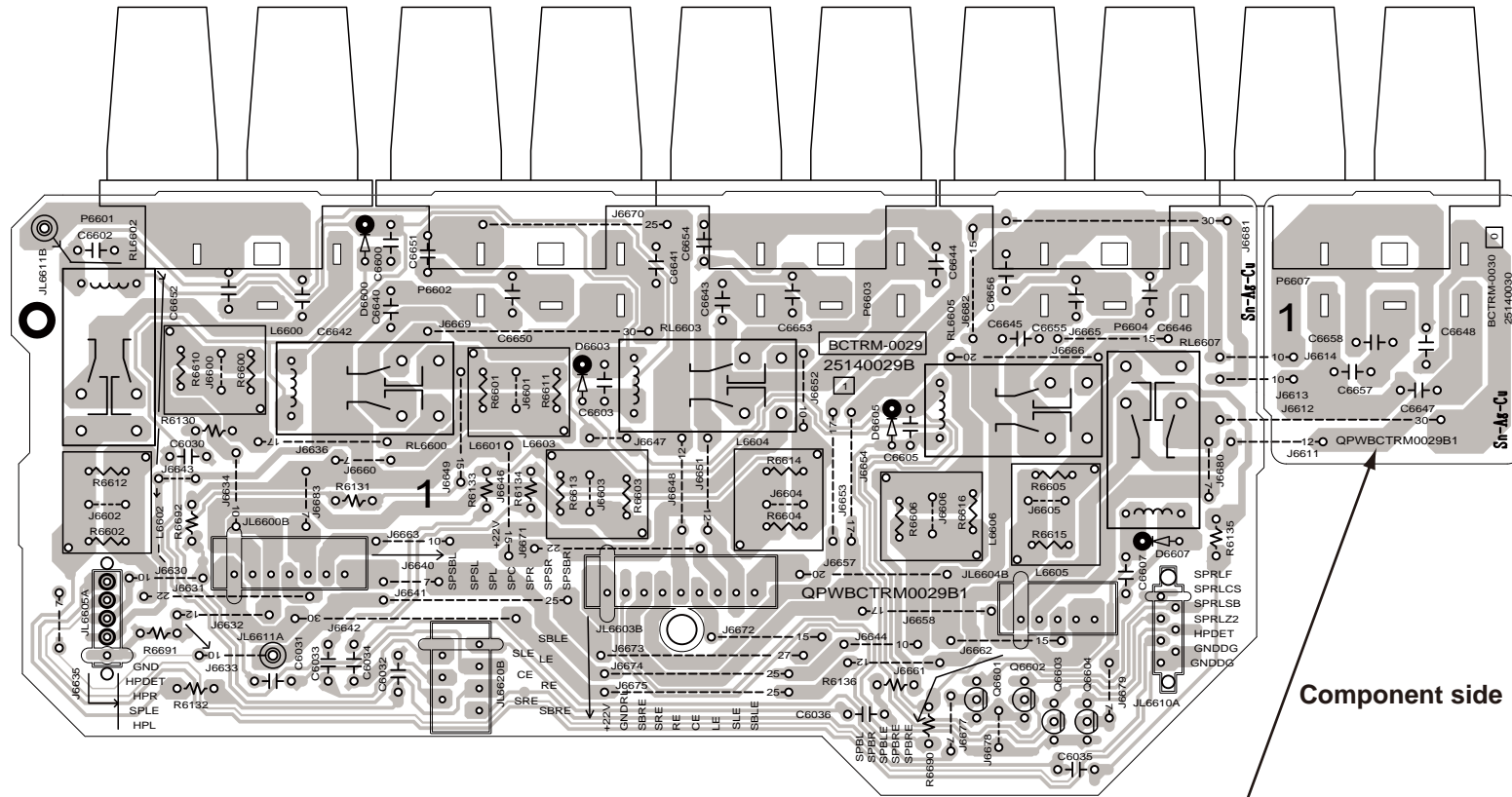

Component side

U0052 D4 TERMINAL PC BOARD
(BAVD-0031)

TX-SA507/607 only

Component side

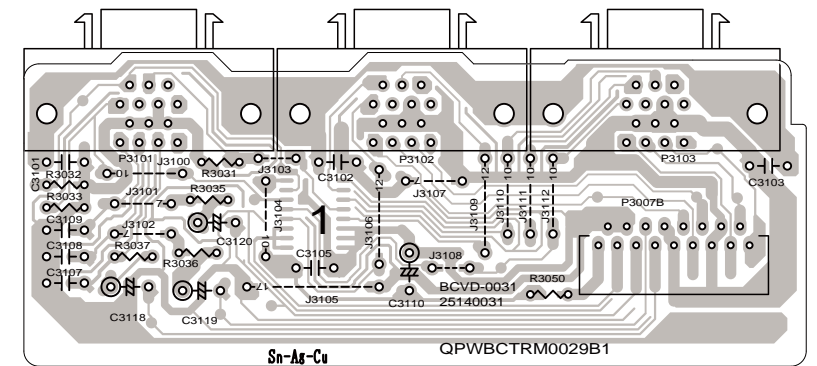

U005 SP TERMINAL PC BOARD
(BATRM-0029)

Soldering side

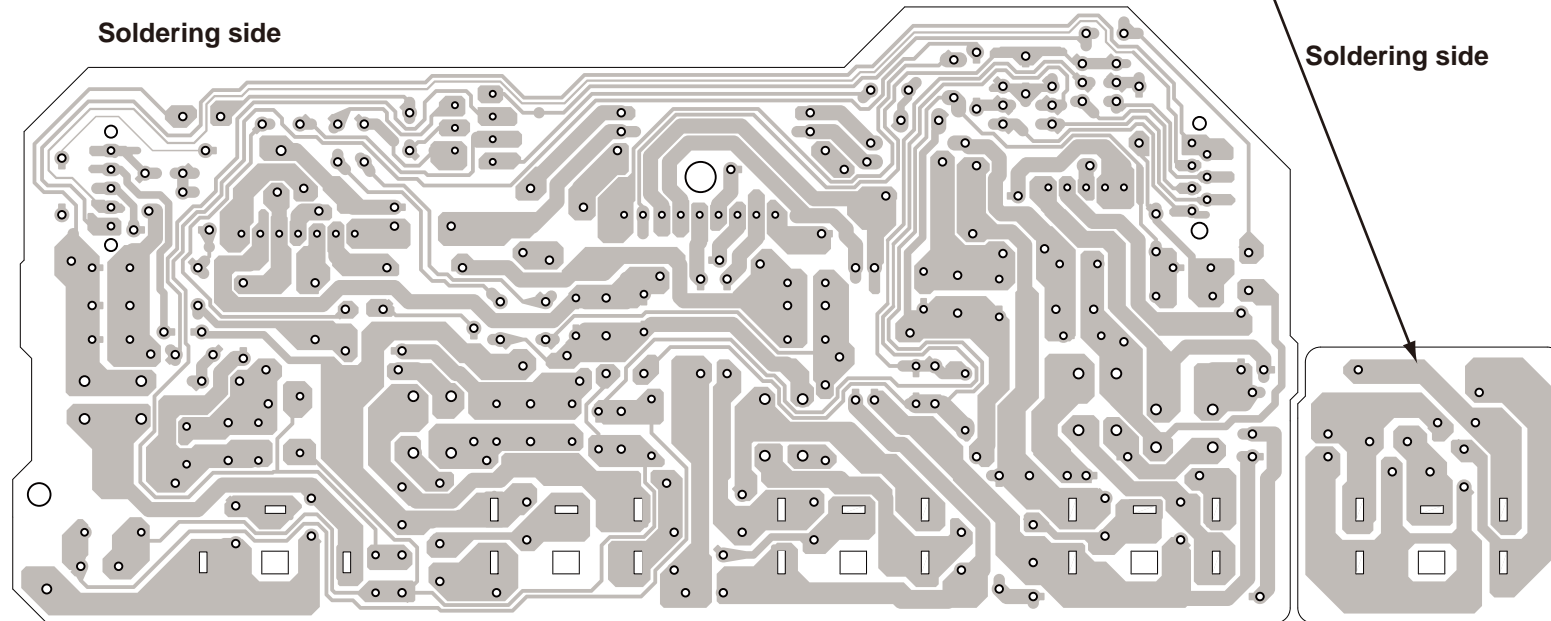

Soldering side

U0052 D4 TERMINAL PC BOARD
(BAVD-0031)

TX-SA507/607 only

Soldering side

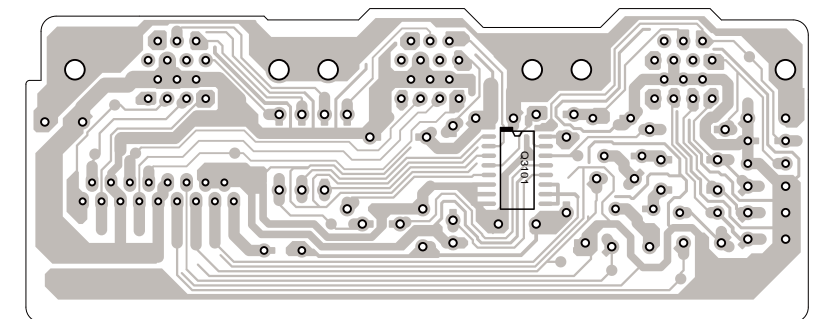

1

2

3

4

5

U0051 FRONT HIGH L/R SP TERMINAL PC BOARD
(BATRM-0030)

TX-SR607 <MO, MQ, PA, PB, PP, MR>, TX-SA607 only

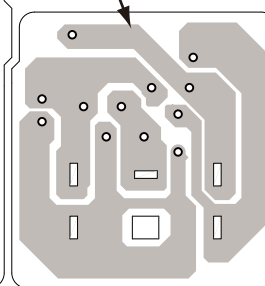

TX-SR507**<Note>**

Parts marked by "NSP" are generally unavailable because they are not in our Master Spare Parts List.

**NOTE : THE COMPONENTS IDENTIFIED BY THE MARK
! ARE CRITICAL FOR RISK OF FIRE AND
ELECTRIC SHOCK. REPLACE ONLY WITH PART
NUMBER SPECIFIED.**

<Notes>

(B) : Black model

(S) : Silver model

(G) : Golden model

<DC> : 120V,Canadian model

<DD> : 120V,USA model

<DF> : 120V,Taiwanese model

<MO> : 220/230-240V,Saudi Arabian model

<MQ> : 220/230-240V,Hong kong model

<PA> : 230V,Australian model

<PB> : 230V,UK model

<PP> : 230V,CE(European) country model

<MR> : 220/230-240V,Chinese model

EXPLODED VIEW PARTS LIST

REF. NO.	PART NAME	DESCRIPTION	Q'TY	PART NO. (SN)	REMARKS
U001	Input selector/Volume/Power amp. pc board AS	BAAF-0008-1A	1	1B232508-1A	N <MDC,MDD,MDF>
U0011	Trans 2nd terminal pc board AS	BAPS-0009-1A	1	1B232509-1A	<MDC,MDD,MDF>
U0012	Trans 2nd terminal pc board AS	BAPS-0010-1A	1	1B232510-1A	<MDC,MDD,MDF>
U0013	Thermal sensor pc board AS	BAETC-0011-1A	1	1B232511-1A	<MDC,MDD,MDF>
U0014	Holder pc board AS	BAETC-0012-1A	1	1B232512-1A	<MDC,MDD,MDF>

U0015	Holder pc board AS	BAETC-0013-1A	1	1B232513-1A	<MDC,MDD,MDF>
U001	Input selector/Volume/Power amp. pc board AS	BAAF-0008-1B	1	1B232508-1B	N <MPA,MPB,MPP>
U0011	Trans 2nd terminal pc board AS	BAPS-0009-1B	1	1B232509-1B	<MPA,MPB,MPP>
U0012	Trans 2nd terminal pc board AS	BAPS-0010-1B	1	1B232510-1B	<MPA,MPB,MPP>
U0013	Thermal sensor pc board AS	BAETC-0011-1B	1	1B232511-1B	<MPA,MPB,MPP>
U0014	Holder pc board AS	BAETC-0012-1B	1	1B232512-1B	<MPA,MPB,MPP>
U0015	Holder pc board AS	BAETC-0013-1B	1	1B232513-1B	<MPA,MPB,MPP>
U001	Input selector/Volume/Power amp. pc board AS	BAAF-0008-1C	1	1B232508-1C	N <MMO,MMQ,MMR>
U0011	Trans 2nd terminal pc board AS	BAPS-0009-1C	1	1B232509-1C	<MMO,MMQ,MMR>
U0012	Trans 2nd terminal pc board AS	BAPS-0010-1C	1	1B232510-1C	<MMO,MMQ,MMR>
U0013	Thermal sensor pc board AS	BAETC-0011-1C	1	1B232511-1C	<MMO,MMQ,MMR>
U0014	Holder pc board AS	BAETC-0012-1C	1	1B232512-1C	<MMO,MMQ,MMR>
U0015	Holder pc board AS	BAETC-0013-1C	1	1B232513-1C	<MMO,MMQ,MMR>
U002	MPU/CODEC pc board AS	BADG-0025-1A	1	1B232525-1A	N <MDC,MDD,MDF>
U0021	Universal port pc board AS	BAETC-0027-1A	1	1B232527-1A	<MDC,MDD,MDF>
U002	MPU/CODEC pc board AS	BADG-0025-1B	1	1B232525-1B	N <MPB,MPP>
U0021	Universal port pc board AS	BAETC-0027-1B	1	1B232527-1B	<MPB,MPP>
U002	MPU/CODEC pc board AS	BADG-0025-1C	1	1B232525-1C	N <MMO,MMQ,MPA,MMR>
U0021	Universal port pc board AS	BAETC-0027-1C	1	1B232527-1C	<MMO,MMQ,MPA,MMR>
U003	Diplay pc board AS	BADIS-0036-1G	1	1B232536-1G	N <MDC,MDD,MDF>
U0031	Switch pc board AS	BADIS-0037-1G	1	1B232537-1G	<MDC,MDD,MDF>
U0032	Video pc board AS	BAVD-0038-1G	1	1B232538-1G	<MDC,MDD,MDF>
U0033	Power supply pc board AS	BAPS-0039-1G	1	1B232539-1G	<MDC,MDD,MDF>
U0034	Headphone pc board AS	BAETC-0040-1G	1	1B232540-1G	<MDC,MDD,MDF>
U003	Diplay pc board AS	BADIS-0036-1H	1	1B232536-1H	N <MPA,MPB,MPP>
U0031	Switch pc board AS	BADIS-0037-1H	1	1B232537-1H	<MPA,MPB,MPP>
U0032	Video pc board AS	BAVD-0038-1H	1	1B232538-1H	<MPA,MPB,MPP>
U0033	Power supply pc board AS	BAPS-0039-1H	1	1B232539-1H	<MPA,MPB,MPP>
U0034	Headphone pc board AS	BAETC-0040-1H	1	1B232540-1H	<MPA,MPB,MPP>
U003	Diplay pc board AS	BADIS-0036-1J	1	1B232536-1J	N <MMO,MMQ,MMR>
U0031	Switch pc board AS	BADIS-0037-1J	1	1B232537-1J	<MMO,MMQ,MMR>
U0032	Video pc board AS	BAVD-0038-1J	1	1B232538-1J	<MMO,MMQ,MMR>
U0033	Power supply pc board AS	BAPS-0039-1J	1	1B232539-1J	<MMO,MMQ,MMR>

U0034	Headphone pc board AS	BAETC-0040-1J	1	1B232540-1J	<MMO,MMQ,MMR>
U004	HDMI / DSP pc board AS	BAHDM-0060-1A	1	1B232560-1A	N
U005	SP terminal pc board AS	BATRM-0029-1A	1	1B232529-1A	N <MDC,MDD,MDF>
U005	SP terminal pc board AS	BATRM-0029-1B	1	1B232529-1B	N <MMO,MMQ,MPA,MPB,MPP,MMR>
U010	TUNER UNIT	FAEH06-E01EX	1	240165	N <MMO,MMQ,MPA,MPB,MPP,MMR>
U010	TUNER UNIT	FAEH06-A01US	1	240166	N <MDC,MDD,MDF>
Q6050	TR	2SC5198-O	1	2203063	
Q6050 or	TR	2SC4468-O	(1)	2202523	EXCEPT <MPB,MPP>
Q6050 or	TR	2SC4468-Y	(1)	2202524	EXCEPT <MPB,MPP>
Q6050 or	TR	2SC4468-P	(1)	2202526	EXCEPT <MPB,MPP>
Q6050 or	TR	2SC5198-R	(1)	2203062	
Q6050 or	TR	MN130S-O	(1)	2203663	EXCEPT <MPB,MPP>
Q6050 or	TR	MN130S-Y	(1)	2203664	EXCEPT <MPB,MPP>
Q6050 or	TR	MN130S-P	(1)	2203666	EXCEPT <MPB,MPP>
Q6050A	ISO SHEET	AC238	4	223024	
Q6050B	ISO SHEET	ISO SHEET	3	223050	
Q6051	TR	2SC5198-O	1	2203063	
Q6051 or	TR	2SC4468-O	(1)	2202523	EXCEPT <MPB,MPP>
Q6051 or	TR	2SC4468-Y	(1)	2202524	EXCEPT <MPB,MPP>
Q6051 or	TR	2SC4468-P	(1)	2202526	EXCEPT <MPB,MPP>
Q6051 or	TR	2SC5198-R	(1)	2203062	
Q6051 or	TR	MN130S-O	(1)	2203663	EXCEPT <MPB,MPP>
Q6051 or	TR	MN130S-Y	(1)	2203664	EXCEPT <MPB,MPP>
Q6051 or	TR	MN130S-P	(1)	2203666	EXCEPT <MPB,MPP>
Q6052	TR	2SC5198-O	1	2203063	
Q6052 or	TR	2SC4468-O	(1)	2202523	EXCEPT <MPB,MPP>
Q6052 or	TR	2SC4468-Y	(1)	2202524	EXCEPT <MPB,MPP>
Q6052 or	TR	2SC4468-P	(1)	2202526	EXCEPT <MPB,MPP>
Q6052 or	TR	2SC5198-R	(1)	2203062	
Q6052 or	TR	MN130S-O	(1)	2203663	EXCEPT <MPB,MPP>
Q6052 or	TR	MN130S-Y	(1)	2203664	EXCEPT <MPB,MPP>
Q6052 or	TR	MN130S-P	(1)	2203666	EXCEPT <MPB,MPP>
Q6055	TR	2SC5198-O	1	2203063	

Q6055 or	TR	2SC4468-O	(1)	2202523	EXCEPT <MPB,MPP>
Q6055 or	TR	2SC4468-Y	(1)	2202524	EXCEPT <MPB,MPP>
Q6055 or	TR	2SC4468-P	(1)	2202526	EXCEPT <MPB,MPP>
Q6055 or	TR	2SC5198-R	(1)	2203062	
Q6055 or	TR	MN130S-O	(1)	2203663	EXCEPT <MPB,MPP>
Q6055 or	TR	MN130S-Y	(1)	2203664	EXCEPT <MPB,MPP>
Q6055 or	TR	MN130S-P	(1)	2203666	EXCEPT <MPB,MPP>
Q6055 or	TR	KTC5242A-R	(1)	2203952	EXCEPT <MPB,MPP>
Q6055 or	TR	KTC5242A-O	(1)	2203953	EXCEPT <MPB,MPP>
Q6056	TR	2SC5198-O	1	2203063	
Q6056 or	TR	2SC4468-O	(1)	2202523	EXCEPT <MPB,MPP>
Q6056 or	TR	2SC4468-Y	(1)	2202524	EXCEPT <MPB,MPP>
Q6056 or	TR	2SC4468-P	(1)	2202526	EXCEPT <MPB,MPP>
Q6056 or	TR	2SC5198-R	(1)	2203062	
Q6056 or	TR	MN130S-O	(1)	2203663	EXCEPT <MPB,MPP>
Q6056 or	TR	MN130S-Y	(1)	2203664	EXCEPT <MPB,MPP>
Q6056 or	TR	MN130S-P	(1)	2203666	EXCEPT <MPB,MPP>
Q6056 or	TR	KTC5242A-R	(1)	2203952	EXCEPT <MPB,MPP>
Q6056 or	TR	KTC5242A-O	(1)	2203953	EXCEPT <MPB,MPP>
Q6060	TR	2SA1941-O	1	2203053	
Q6060 or	TR	2SA1695-O	(1)	2202513	EXCEPT <MPB,MPP>
Q6060 or	TR	2SA1695-Y	(1)	2202514	EXCEPT <MPB,MPP>
Q6060 or	TR	2SA1695-P	(1)	2202516	EXCEPT <MPB,MPP>
Q6060 or	TR	2SA1941-R	(1)	2203052	
Q6060 or	TR	MP130S-O	(1)	2203673	EXCEPT <MPB,MPP>
Q6060 or	TR	MP130S-Y	(1)	2203674	EXCEPT <MPB,MPP>
Q6060 or	TR	MP130S-P	(1)	2203676	EXCEPT <MPB,MPP>
Q6061	TR	2SA1941-O	1	2203053	
Q6061 or	TR	2SA1695-O	(1)	2202513	EXCEPT <MPB,MPP>
Q6061 or	TR	2SA1695-Y	(1)	2202514	EXCEPT <MPB,MPP>
Q6061 or	TR	2SA1695-P	(1)	2202516	EXCEPT <MPB,MPP>
Q6061 or	TR	2SA1941-R	(1)	2203052	
Q6061 or	TR	MP130S-O	(1)	2203673	EXCEPT <MPB,MPP>

Q6061 or	TR	MP130S-Y	(1)	2203674	EXCEPT <MPB,MPP>
Q6061 or	TR	MP130S-P	(1)	2203676	EXCEPT <MPB,MPP>
Q6062	TR	2SA1941-O	1	2203053	
Q6062 or	TR	2SA1695-O	(1)	2202513	EXCEPT <MPB,MPP>
Q6062 or	TR	2SA1695-Y	(1)	2202514	EXCEPT <MPB,MPP>
Q6062 or	TR	2SA1695-P	(1)	2202516	EXCEPT <MPB,MPP>
Q6062 or	TR	2SA1941-R	(1)	2203052	
Q6062 or	TR	MP130S-O	(1)	2203673	EXCEPT <MPB,MPP>
Q6062 or	TR	MP130S-Y	(1)	2203674	EXCEPT <MPB,MPP>
Q6062 or	TR	MP130S-P	(1)	2203676	EXCEPT <MPB,MPP>
Q6065	TR	2SA1941-O	1	2203053	
Q6065 or	TR	2SA1695-O	(1)	2202513	EXCEPT <MPB,MPP>
Q6065 or	TR	2SA1695-Y	(1)	2202514	EXCEPT <MPB,MPP>
Q6065 or	TR	2SA1695-P	(1)	2202516	EXCEPT <MPB,MPP>
Q6065 or	TR	2SA1941-R	(1)	2203052	
Q6065 or	TR	MP130S-O	(1)	2203673	EXCEPT <MPB,MPP>
Q6065 or	TR	MP130S-Y	(1)	2203674	EXCEPT <MPB,MPP>
Q6065 or	TR	MP130S-P	(1)	2203676	EXCEPT <MPB,MPP>
Q6065 or	TR	KTA1962A-R	(1)	2203942	EXCEPT <MPB,MPP>
Q6065 or	TR	KTA1962A-O	(1)	2203943	EXCEPT <MPB,MPP>
Q6066	TR	2SA1941-O	1	2203053	
Q6066 or	TR	2SA1695-O	(1)	2202513	EXCEPT <MPB,MPP>
Q6066 or	TR	2SA1695-Y	(1)	2202514	EXCEPT <MPB,MPP>
Q6066 or	TR	2SA1695-P	(1)	2202516	EXCEPT <MPB,MPP>
Q6066 or	TR	2SA1941-R	(1)	2203052	
Q6066 or	TR	MP130S-O	(1)	2203673	EXCEPT <MPB,MPP>
Q6066 or	TR	MP130S-Y	(1)	2203674	EXCEPT <MPB,MPP>
Q6066 or	TR	MP130S-P	(1)	2203676	EXCEPT <MPB,MPP>
Q6066 or	TR	KTA1962A-R	(1)	2203942	EXCEPT <MPB,MPP>
Q6066 or	TR	KTA1962A-O	(1)	2203943	EXCEPT <MPB,MPP>

<Note>

Must use the same HFE rank mutually about the following parts.

Ref. No. : Q6050-Q6060, Q6051-Q6061, Q6052-Q6062, Q6053-Q6063, Q6054-Q6064, Q6055-Q6065, Q6056-Q6066

T901	P TRANS	NPT-1516D	1	2301798	! <MDC,MDD,MDF>
T901	P TRANS	NPT-1516P	1	2301799	! <MPA,MPB,MPP>
T901	P TRANS	NPT-1516DQ	1	2301801	! <MMO,MMQ,MMR>
F6901	FUSE	10A-UL/T-233	1	252330GR	!
F6901 or	FUSE	10A-T/UL-ST2	(1)	252333GR	!
F6902	FUSE	10A-UL/T-233	1	252330GR	!
F6902 or	FUSE	10A-T/UL-ST2	(1)	252333GR	!
F901	FUSE	4A-SE-EAK FUSE	1	252077GR	! <MMO,MMQ,MPA,MPB,MPP,MMR>
F901	FUSE	8A-UL/T-233	1	252329GR	! <MDC,MDD,MDF>
F901 or	FUSE	8A-T/UL-ST2	(1)	252261GR	! <MDC,MDD,MDF>
F901 or	FUSE	4A-SE-TL250V	(1)	252277GR	! <MMO,MMQ,MPA,MPB,MPP,MMR>
P101	FFC	NCFC7-112012	1	2047112012	
P6601A	P RIVET	JB-407A-C	10	880052	<MMO,MMQ,MPA,MPB,MPP,MMR>
P701	FFC	NCFC7-332012	1	2047332012	
P901	AC CORD	AS-BS	1	253198LTK	! <MMQ>
P901	AC CORD	AS-BS	1	253198VOL	! <MPB>
P901	AC CORD	AS-CEE-2	1	253306VOL	! <MMO,MPP>
P901	AC CORD	AS-CCC	1	253355VOL	! <MMR>
P901	AC CORD	AS-UC-2	1	253368AYUN	! <MDC,MDD>
P901	AC CORD	AS-SAA	1	253388LTK	! <MPA>
P901	AC CORD	AS-CNS	1	253429VOL	! <MDF>
P901 or	AC CORD	AS-BS	(1)	253198LTK	! <MPB>
P901 or	AC CORD	AS-UC-2	(1)	253368BLTK	! <MDC,MDD>
P901 or	AC CORD	AS-CEE-2	(1)	253374YUN	! <MMO,MPP>
P901 or	AC CORD	AS-CCC	(1)	253377LTK	! <MMR>
A001	CHASSIS	TX-SR507	1	27100533B	
A003	BOTTOM LEG	.	4	27175432C	
A005	CUSHION	.	4	28141664	
A007	SCREW	3TTB+8B(3CM)SR	4	801637	
A009	HOLDER	KGLS-8RT	3	27190503A	
A010	HOLDER	KGPS-8RF	1	27191044	
A011	HOLDER	KGLS-10RT	1	27190428A	
A013	HOLDER	KGPS-14RF	2	27190802	

A015	HOLDER	KGPS-14RF	1	27190802	
A017	HOLDER	KGLS-16S	1	27190607	
A019	HOLDER	KGPS-16RF	1	27190991	
A021	HOLDER	KGLS-22S	2	27190369	
A023	HOLDER	KGLS-22S	1	27190369	
A025	SCREW	4TTC+8C(3BC)	4	830440089GR	
A030	HEAT SINK	507	1	27160633	N
A032	RETAINER	(HL)	1	27142138A	
A034	RETAINER	(HR)	1	27142139A	
A036	SCREW	3TTB+8B(3CM)SR	4	801637	
A038	SCREW	3TTB+8B(3CM)SR	2	801637	
A040	SCREW	3TTB+8B(3CM)SR	4	801637	
A042	SCREW	3TTB+8B(3CM)SR	2	801637	
A044	HOLDER	KGLS-8RT	1	27190503A	
A050	SCREW	3SMS8W.SW+14B(CU)	10	801634	
A054	SCREW	3TTB+8B(3CM)SR	1	801637	
A056	BUSHING	S-RELIEF #2271	1	27300750	
A058	LABEL	(PT)	1	29363379-1	
A060	WIRE TIE	BINDER(CLAMPER)UL	3	260258	
A062	WIRE TIE	BSK-1	3	260208	
A069	SCREW	3TTB+8B(3BC)	1	838430088GR	
A070	LABEL	(SP)507	1	29390689	N
A101	REAR PANEL	507DD	1	27123975A	N <MDC,MDD,MDF>
A101	REAR PANEL	507PP	1	27123976B	N <MPA,MPB,MPP>
A101	REAR PANEL	507MO	1	27123977A	N <MMO,MMQ>
A101	REAR PANEL	507MR	1	27123978A	N <MMR>
A102	CUSHION	.	2	28141799	
A103	SCREW	3P+6FN(3BC)	7	82143006GR	
A105	SCREW	3TTB+8B(3BC)	29	838430088GR	
A201	F PANEL	507(B)DD	1	27213205B	N <BMDC,BMDD,BMDF>
A201	F PANEL	507(S)DD	1	27213206B	N <SMDD>
A201	F PANEL	507(B)PP	1	27213207B	N <BMPB,BMPP>
A201	F PANEL	507(S)PP	1	27213208B	N <SMPB,SMPP>

A201	F PANEL	507(B)MO	1	27213209B	N <BMMO,BMMQ,BMPA>
A201	F PANEL	507(S)MO	1	27213210B	N <SMMO,SMQA>
A201	F PANEL	507(G)MR	1	27213211B	N <GMMR>
A201	F PANEL	507DF	1	27213294A	N <GMDF>
A202	CLEAR PLT	(AS)507/607P	1	28192255	<MPB,MPP>
A202	CLEAR PLT	(AS)507/607O	1	28192256	<MMO,MMQ,MPA,MMR>
A202	CLEAR PLT	(AS)507/607D	1	28192257	<MDC,MDD,MDF>
A207	BADGE	BADGE	1	28135244	
A207	BADGE	BADGE	1	28135245	<G>
A207	BADGE	.	1	28135298	<S>
A213	KNOB	(INP)	1	28326666	N
A213	KNOB	(INP)	1	28326667	<S>
A213	KNOB	(INP)	1	28326668	<G>
A215	KNOB	(SEL)	1	28326665	N
A217	KNOB	(STNBY)	1	28326663	N
A219	KNOB	(CUR)	1	28326664A	
A221	IB CUSHION	W15*3t TAPE	1	28141585	
A225	SCREW	2.6TTB+8B(3BC)	27	838426088GR	
A230	RETAINER	(U)	1	27142135A	
A232	SCREW	2.6TTB+8B(3BC)	5	838426088GR	
A234	RETAINER	(L)	1	27142133A	
A236	RETAINER	(R)	1	27142134A	
A238	SCREW	2.6TTB+8B(3BC)	4	838426088GR	
A250	B PLATE	.	1	28133425	
A250	B PLATE	.	1	28133426	<G,S>
A254	WIRE TIE	BSK-1	8	260208	
A256	SCREW	3TTB+8B(3CM)SR	1	801637	
A258	SCREW	3TTB+8B(3CM)SR	4	801637	
A260	SCREW	3TTB+8B(3BC)	3	838430088GR	
A262	TAPE	TAPE(CLOTH-16U)	1	29110083	
A264	CUSHION	.	3	28141681	
A330	KNOB	(VOL) BLACK	1	28326514	
A330	KNOB	(VOL) GOLD	1	28326624	<G>

A330	KNOB	(VOL) SILVER	1	28326669	<S>
A340	COVER	(B) (Bent)	1	28210031	
A340	COVER	(S) (Bent)	1	28210032	<S>
A340	COVER	(G) (Bent)	1	28210033	<G>
A340	COVER	(B) (Not Bent)	1	28210031Z	
A340	COVER	(S) (Not Bent)	1	28210032Z	<S>
A340	COVER	(G) (Not Bent)	1	28210033Z	<G>
A342	SCREW	3TTB+8B(3BC)	7	838430088GR	
A344	SCREW	3TTB+8B(3CM)SR	7	801637	<G,S>
A350	PLATE	(COVER)	1	27262834A	<BMMO,BMMQ>
A350	PLATE	(COVER)	1	27262835A	<GMMR,SMMO>
A354	HOLDER	(PLATE)	8	27191337	<BMMO,BMMQ>
A354	HOLDER	(PLATE)	8	27191333A	<GMMR,SMMO>
A360	LABEL	(COVER)	1	29390767	
A362	LABEL	HOOKUP-ONKYO	1	29363194	<MDC,MDD>

TX-SR507

PC BOARD PARTS LIST

- U001** Input selector/Volume/Power amp. pc board AS (BAAF-0008-1A/1B/1C)
- U0011** Trans 2nd terminal pc board AS (BAPS-0009-1A/1B/1C)
- U0012** Trans 2nd terminal pc board AS (BAPS-0010-1A/1B/1C)
- U0013** Thermal sensor pc board AS (BAETC-0011-1A/1B/1C)
- U0014** Holder pc board AS (BAETC-0012-1A/1B/1C)
- U0015** Holder pc board AS (BAETC-0013-1A/1B/1C)

CIRCUIT NO.	PART NAME	DESCRIPTION	Q'TY	PART NO. (SN)	REMARKS
D5000	ZENER D	MTZJ5.6B	1	224470562T	
D5001	ZENER D	MTZJ5.6B	1	224470562T	
D5002	ZENER D	MTZJ5.6B	1	224470562T	
D5005	ZENER D	MTZJ5.6B	1	224470562T	
D5006	ZENER D	MTZJ5.6B	1	224470562T	
D5671	ZENER D	MTZJ6.2B	1	224470622T	

D5672	ZENER D	MTZJ6.2B	1	224470622T
D5673	DIODE	ISS133	1	223163T
D5674	DIODE	ISS133	1	223163T
D5706	C-DIODE	KDS4148U	1	223283R2
D5706 or	C-DIODE	ISS352	(1)	223234R2
D5706 or	C-DIODE	MA2J111	(1)	223279R2
D5707	C-DIODE	KDS4148U	1	223283R2
D5707 or	C-DIODE	ISS352	(1)	223234R2
D5707 or	C-DIODE	MA2J111	(1)	223279R2
D5708	C-DIODE	KDS4148U	1	223283R2
D5708 or	C-DIODE	ISS352	(1)	223234R2
D5708 or	C-DIODE	MA2J111	(1)	223279R2
D5716	C-DIODE	KDS4148U	1	223283R2
D5716 or	C-DIODE	ISS352	(1)	223234R2
D5716 or	C-DIODE	MA2J111	(1)	223279R2
D5717	C-DIODE	KDS4148U	1	223283R2
D5717 or	C-DIODE	ISS352	(1)	223234R2
D5717 or	C-DIODE	MA2J111	(1)	223279R2
D5718	C-DIODE	KDS4148U	1	223283R2
D5718 or	C-DIODE	ISS352	(1)	223234R2
D5718 or	C-DIODE	MA2J111	(1)	223279R2
D5800	DIODE	RL1N4003	1	22380260T
D5801	DIODE	RL1N4003	1	22380260T
D5802	DIODE	RL1N4003	1	22380260T
D5803	DIODE	RL1N4003	1	22380260T
D5804	DIODE	RL1N4003	1	22380260T
D5805	DIODE	RL1N4003	1	22380260T
D6000	C-DIODE	KDS4148U	1	223283R2
D6000 or	C-DIODE	ISS352	(1)	223234R2
D6000 or	C-DIODE	MA2J111	(1)	223279R2
D6001	C-DIODE	KDS4148U	1	223283R2
D6001 or	C-DIODE	ISS352	(1)	223234R2
D6001 or	C-DIODE	MA2J111	(1)	223279R2

D6002	C-DIODE	KDS4148U	1	223283R2
D6002 or	C-DIODE	1SS352	(1)	223234R2
D6002 or	C-DIODE	MA2J111	(1)	223279R2
D6005	C-DIODE	KDS4148U	1	223283R2
D6005 or	C-DIODE	1SS352	(1)	223234R2
D6005 or	C-DIODE	MA2J111	(1)	223279R2
D6006	C-DIODE	KDS4148U	1	223283R2
D6006 or	C-DIODE	1SS352	(1)	223234R2
D6006 or	C-DIODE	MA2J111	(1)	223279R2
D6701	C-DIODE	KDS4148U	1	223283R2
D6701 or	C-DIODE	1SS352	(1)	223234R2
D6701 or	C-DIODE	MA2J111	(1)	223279R2
D6702	C-DIODE	KDS4148U	1	223283R2
D6702 or	C-DIODE	1SS352	(1)	223234R2
D6702 or	C-DIODE	MA2J111	(1)	223279R2
D6703	ZENER D	UDZS3.3B	1	224550330R2
D6704	ZENER D	UDZS3.3B	1	224550330R2
D6713	ZENER D	UDZS3.3B	1	224550330R2
D6901	DIODE	D10XB60H	1	22380337
D6901A	HEAT SINK	RAD-196	1	27160545
D6901C	SCREW	3P+10FN(3BC)	2	82143010GR
D6902	C-DIODE	KDS4148U	1	223283R2
D6902 or	C-DIODE	1SS352	(1)	223234R2
D6902 or	C-DIODE	MA2J111	(1)	223279R2
D6903	DIODE	D10XB60H	1	22380337
Q5000	TR	2SC2240-BL(TPE2_F)	1	2211406T
Q5001	TR	2SC2240-BL(TPE2_F)	1	2211406T
Q5002	TR	2SC2240-BL(TPE2_F)	1	2211406T
Q5005	TR	2SC2240-BL(TPE2_F)	1	2211406T
Q5006	TR	2SC2240-BL(TPE2_F)	1	2211406T
Q5010	TR	2SC2240-BL(TPE2_F)	1	2211406T
Q5011	TR	2SC2240-BL(TPE2_F)	1	2211406T
Q5012	TR	2SC2240-BL(TPE2_F)	1	2211406T

Q5015	TR	2SC2240-BL(TPE2_F)	1	2211406T	
Q5016	TR	2SC2240-BL(TPE2_F)	1	2211406T	
Q5030	TR	2SA949-Y(TPE6_F)	1	2211354T	
Q5031	TR	2SA949-Y(TPE6_F)	1	2211354T	
Q5032	TR	2SA949-Y(TPE6_F)	1	2211354T	
Q5035	TR	2SA949-Y(TPE6_F)	1	2211354T	
Q5036	TR	2SA949-Y(TPE6_F)	1	2211354T	
Q5040	TR	2SC2229-Y(TPE6_F)	1	2211634T	
Q5041	TR	2SC2229-Y(TPE6_F)	1	2211634T	
Q5042	TR	2SC2229-Y(TPE6_F)	1	2211634T	
Q5045	TR	2SC2229-Y(TPE6_F)	1	2211634T	
Q5046	TR	2SC2229-Y(TPE6_F)	1	2211634T	
Q5050	TR	2SC1815-GR	1	2211255T	
Q5051	TR	2SC1815-GR	1	2211255T	
Q5052	TR	2SC1815-GR	1	2211255T	
Q5055	TR	2SC1815-GR	1	2211255T	
Q5056	TR	2SC1815-GR	1	2211255T	
Q5501	IC	R2A15218FP	1	22242605R3	N
Q5503	IC	NJM4580M-D	1	22241448R2	
Q5600	TR	RN1441	1	2215410R2	
Q5601	TR	RN1441	1	2215410R2	
Q5602	TR	RN1441	1	2215410R2	
Q5603	TR	RN1441	1	2215410R2	
Q5604	TR	RN1441	1	2215410R2	
Q5605	TR	RN1441	1	2215410R2	
Q5606	TR	RN1441	1	2215410R2	
Q5607	TR	RN1441	1	2215410R2	
Q5608	TR	RN1441	1	2215410R2	
Q5609	TR	RN1441	1	2215410R2	
Q5613	TR	RN1441	1	2215410R2	
Q5614	TR	RN1441	1	2215410R2	
Q5617	TR	RN1441	1	2215410R2	
Q5630	IC	NJM4580M-D	1	22241448R2	

Q5670	IC	78M15HF(NJM78M15FA)	1	222780155JRC
Q5670 or	IC	UPC78M15AHF-AZ	(1)	222780155NEC
Q5670A	HEAT SINK	RAD-196	1	27160545
Q5670B	SCREW	3P+10FN(3BC)	1	82143010GR
Q5671	IC	79M15HF(NJM79M15FA)	1	222790155JRC
Q5671 or	IC	UPC79M15HF-AZ	(1)	222790155NEC
Q5671B	SCREW	3P+10FN(3BC)	1	82143010GR
Q6000	TR	2SC1740S-S	1	2213285T
Q6001	TR	2SC1740S-S	1	2213285T
Q6002	TR	2SC1740S-S	1	2213285T
Q6005	TR	2SC1740S-S	1	2213285T
Q6006	TR	2SC1740S-S	1	2213285T
Q6010	TR	2SC1740S-S	1	2213285T
Q6011	TR	2SC1740S-S	1	2213285T
Q6012	TR	2SC1740S-S	1	2213285T
Q6015	TR	2SC1740S-S	1	2213285T
Q6016	TR	2SC1740S-S	1	2213285T
Q6030	TR	2SC5171(ONK_Q)	1	2203010
Q6030 or	TR	KTD2061-Y	(1)	2203434
Q6030 or	TR	2SC5993-Q_P	(1)	2217161
Q6031	TR	2SC5171(ONK_Q)	1	2203010
Q6031 or	TR	KTD2061-Y	(1)	2203434
Q6031 or	TR	2SC5993-Q_P	(1)	2217161
Q6032	TR	2SC5171(ONK_Q)	1	2203010
Q6032 or	TR	KTD2061-Y	(1)	2203434
Q6032 or	TR	2SC5993-Q_P	(1)	2217161
Q6035	TR	2SC5171(ONK_Q)	1	2203010
Q6035 or	TR	KTD2061-Y	(1)	2203434
Q6035 or	TR	2SC5993-Q_P	(1)	2217161
Q6036	TR	2SC5171(ONK_Q)	1	2203010
Q6036 or	TR	KTD2061-Y	(1)	2203434
Q6036 or	TR	2SC5993-Q_P	(1)	2217161
Q6040	TR	2SA1930(ONK_Q)	1	2203000

Q6040 or	TR	KTB1369-Y	(1)	2203424
Q6040 or	TR	2SA2140-Q_P	(1)	2217151
Q6041	TR	2SA1930(ONK_Q)	1	2203000
Q6041 or	TR	KTB1369-Y	(1)	2203424
Q6041 or	TR	2SA2140-Q_P	(1)	2217151
Q6042	TR	2SA1930(ONK_Q)	1	2203000
Q6042 or	TR	KTB1369-Y	(1)	2203424
Q6042 or	TR	2SA2140-Q_P	(1)	2217151
Q6045	TR	2SA1930(ONK_Q)	1	2203000
Q6045 or	TR	KTB1369-Y	(1)	2203424
Q6045 or	TR	2SA2140-Q_P	(1)	2217151
Q6046	TR	2SA1930(ONK_Q)	1	2203000
Q6046 or	TR	KTB1369-Y	(1)	2203424
Q6046 or	TR	2SA2140-Q_P	(1)	2217151
Q6070	TR	2SC2229-Y(TPE6_F)	1	2211634T
Q6071	TR	2SC2229-Y(TPE6_F)	1	2211634T
Q6072	TR	2SC2229-Y(TPE6_F)	1	2211634T
Q6075	TR	2SC2229-Y(TPE6_F)	1	2211634T
Q6076	TR	2SC2229-Y(TPE6_F)	1	2211634T
Q6380	IC	LM61CIZ	1	22242212
Q6380A	RETAINER	(PTH)	1	27141884-1
Q6701	TR	2SC2712-GR	1	2213145R2
Q6701 or	TR	KTC3875-GR	(1)	2216175R2
Q6702	TR	2SC2712-GR	1	2213145R2
Q6702 or	TR	KTC3875-GR	(1)	2216175R2
Q6703	TR	2SA1163-BL(TE85L_F)	1	2216756R2
Q6707	TR	2SC2712-GR	1	2213145R2
Q6707 or	TR	KTC3875-GR	(1)	2216175R2
Q6713	TR	2SA1163-BL(TE85L_F)	1	2216756R2
L5501	CHOKE COIL	LBC2518T2R2M	1	231364M022R2
C5000	UPZ C	2AUPZTF221JE	1	376332214T
C5001	UPZ C	2AUPZTF221JE	1	376332214T
C5002	UPZ C	2AUPZTF221JE	1	376332214T

C5005	UPZ C	2AUPZTF221JE	1	376332214T
C5006	UPZ C	2AUPZTF221JE	1	376332214T
C5010	UTSP C	CE04W50V-47M(UTSP)	1	397584707T
C5011	UTSP C	CE04W50V-47M(UTSP)	1	397584707T
C5012	UTSP C	CE04W50V-47M(UTSP)	1	397584707T
C5015	UTSP C	CE04W50V-47M(UTSP)	1	397584707T
C5016	UTSP C	CE04W50V-47M(UTSP)	1	397584707T
C5020	UTSP C	CE04W50V-10M(UTSP)	1	397581007T
C5021	UTSP C	CE04W50V-10M(UTSP)	1	397581007T
C5022	UTSP C	CE04W50V-10M(UTSP)	1	397581007T
C5025	UTSP C	CE04W50V-10M(UTSP)	1	397581007T
C5026	UTSP C	CE04W50V-10M(UTSP)	1	397581007T
C5040	UTSP C	CE04W25V-220M(UTSP)	1	397552217T
C5041	UTSP C	CE04W25V-220M(UTSP)	1	397552217T
C5042	UTSP C	CE04W25V-220M(UTSP)	1	397552217T
C5045	UTSP C	CE04W25V-220M(UTSP)	1	397552217T
C5046	UTSP C	CE04W25V-220M(UTSP)	1	397552217T
C5050	UTSP C	CE04W50V-47M(UTSP)	1	397584707T
C5051	UTSP C	CE04W50V-47M(UTSP)	1	397584707T
C5052	UTSP C	CE04W50V-47M(UTSP)	1	397584707T
C5055	UTSP C	CE04W50V-47M(UTSP)	1	397584707T
C5056	UTSP C	CE04W50V-47M(UTSP)	1	397584707T
C5080	CERA C	CC45SL50V-040C	1	345020401T
C5081	CERA C	CC45SL50V-040C	1	345020401T
C5082	CERA C	CC45SL50V-040C	1	345020401T
C5085	CERA C	CC45SL50V-040C	1	345020401T
C5086	CERA C	CC45SL50V-040C	1	345020401T
C5090	UPZ C	2AUPZTF101JE	1	376331014T
C5091	UPZ C	2AUPZTF101JE	1	376331014T
C5092	UPZ C	2AUPZTF101JE	1	376331014T
C5095	UPZ C	2AUPZTF101JE	1	376331014T
C5096	UPZ C	2AUPZTF101JE	1	376331014T
C5100	VR C	CE04W100V-22M(VR)	1	394692207T

C5101	VR C	CE04W100V-22M(VR)	1	394692207T
C5102	VR C	CE04W100V-22M(VR)	1	394692207T
C5105	VR C	CE04W100V-22M(VR)	1	394692207T
C5106	VR C	CE04W100V-22M(VR)	1	394692207T
C5110	VR C	CE04W100V-22M(VR)	1	394692207T
C5111	VR C	CE04W100V-22M(VR)	1	394692207T
C5112	VR C	CE04W100V-22M(VR)	1	394692207T
C5115	VR C	CE04W100V-22M(VR)	1	394692207T
C5116	VR C	CE04W100V-22M(VR)	1	394692207T
C5503	UPZ C	2AUPZTF221JE	1	376332214T
C5504	UPZ C	2AUPZTF221JE	1	376332214T
C5507	C-CERA C	CC725CH1H-221J1	1	342102214R1
C5508	C-CERA C	CC725CH1H-221J1	1	342102214R1
C5513	C-CERA C	CC725CH1H-221J1	1	342102214R1
C5514	C-CERA C	CC725CH1H-221J1	1	342102214R1
C5517	C-CERA C	CC725CH1H-221J1	1	342102214R1
C5518	C-CERA C	CC725CH1H-221J1	1	342102214R1
C5519	UPZ C	2AUPZTF221JE	1	376332214T
C5520	UPZ C	2AUPZTF221JE	1	376332214T
C5527	C-CERA C	CC725CH1H-221J1	1	342102214R1
C5530	C-CERA C	CC725CH1H-221J1	1	342102214R1
C5531	C-CERA C	CC725CH1H-221J1	1	342102214R1
C5535	C-CERA C	CC725CH1H-221J1	1	342102214R1
C5536	C-CERA C	CC725CH1H-221J1	1	342102214R1
C5550	UTSP C	CE04W25V-47M(UTSP)	1	397554707T
C5551	UTSP C	CE04W25V-47M(UTSP)	1	397554707T
C5552	UTSP C	CE04W25V-47M(UTSP)	1	397554707T
C5553	UTSP C	CE04W25V-47M(UTSP)	1	397554707T
C5554	UTSP C	CE04W25V-47M(UTSP)	1	397554707T
C5555	UTSP C	CE04W25V-47M(UTSP)	1	397554707T
C5556	UTSP C	CE04W25V-47M(UTSP)	1	397554707T
C5557	UTSP C	CE04W25V-47M(UTSP)	1	397554707T
C5560	UTSP C	CE04W25V-47M(UTSP)	1	397554707T

C5561	UTSP C	CE04W25V-47M(UTSP)	1	397554707T
C5562	TF C	ECQ-V50V-474J	1	374724744T
C5563	TF C	ECQ-V50V-823J	1	374728234T
C5564	TF C	ECQ-V50V-223J	1	374722234T
C5565	TF C	ECQ-V50V-474J	1	374724744T
C5566	TF C	ECQ-V50V-823J	1	374728234T
C5567	TF C	ECQ-V50V-223J	1	374722234T
C5570	UTSP C	CE04W50V 47M(UTSP)	1	397584707T
C5571	UTSP C	CE04W50V 47M(UTSP)	1	397584707T
C5572	UTSP C	CE04W50V 47M(UTSP)	1	397584707T
C5573	UTSP C	CE04W50V 47M(UTSP)	1	397584707T
C5574	UTSP C	CE04W50V 47M(UTSP)	1	397584707T
C5575	UTSP C	CE04W50V 47M(UTSP)	1	397584707T
C5576	UTSP C	CE04W50V 47M(UTSP)	1	397584707T
C5577	UTSP C	CE04W50V 47M(UTSP)	1	397584707T
C5585	UTSP C	CE04W25V-47M(UTSP)	1	397554707T
C5586	UTSP C	CE04W25V-47M(UTSP)	1	397554707T
C5590	C-CERA C	CC725CH1H-330J1	1	342103304R1
C5591	C-CERA C	CC725CH1H-330J1	1	342103304R1
C5600	UTSP C	CE04W50V 47M(UTSP)	1	397584707T
C5601	UTSP C	CE04W50V 47M(UTSP)	1	397584707T
C5602	UTSP C	CE04W50V 47M(UTSP)	1	397584707T
C5603	UTSP C	CE04W50V 47M(UTSP)	1	397584707T
C5604	UTSP C	CE04W50V 47M(UTSP)	1	397584707T
C5605	UTSP C	CE04W50V 47M(UTSP)	1	397584707T
C5606	UTSP C	CE04W50V 47M(UTSP)	1	397584707T
C5607	UTSP C	CE04W25V-100M(UTSP)	1	397551017T
C5608	UTSP C	CE04W50V 47M(UTSP)	1	397584707T
C5609	UTSP C	CE04W50V 47M(UTSP)	1	397584707T
C5630	UTSP C	CE04W50V 47M(UTSP)	1	397584707T
C5631	C-CERA C	CC725CH1H-221J1	1	342102214R1
C5632	TF C	ECQ-V50V-103J	1	374721034T
C5666	UTSP C	CE04W25V-220M(UTSP)	1	397552217T

C5667	UTSP C	CE04W25V-220M(UTSP)	1	397552217T
C5670	UTSP C	CE04W50V-10M(UTSP)	1	397581007T
C5671	UTSP C	CE04W50V-10M(UTSP)	1	397581007T
C5672	UTSP C	CE04W25V-220M(UTSP)	1	397552217T
C5673	UTSP C	CE04W25V-220M(UTSP)	1	397552217T
C5674	UTSP C	CE04W16V-470M(UTSP)	1	397544717T
C5675	UTSP C	CE04W16V-470M(UTSP)	1	397544717T
C5703	C-CERA C	CC725CH1H-102J1	1	342101024R1
C5704	C-CERA C	CC725CH1H-102J1	1	342101024R1
C5705	C-CERA C	CC725CH1H-102J1	1	342101024R1
C5707	C-CERA C	CC725CH1H-102J1	1	342101024R1
C5708	C-CERA C	CC725CH1H-102J1	1	342101024R1
C5709	UTSP C	CE04W25V-47M(UTSP)	1	397554707T
C5710	UTSP C	CE04W25V-47M(UTSP)	1	397554707T
C5711	C-CERA C	CC725CH1H-102J1	1	342101024R1
C5800	TF C	ECQ-V50V-334J	1	374723344T
C5801	VR C	CE04W35V-1000M(VR)	1	394661027S
C5802	VR C	CE04W35V-470M(VR)	1	394664717T
C6030	TF C	ECQ-V50V-473J	1	374724734T
C6031	TF C	ECQ-V50V-473J	1	374724734T
C6032	TF C	ECQ-V50V-473J	1	374724734T
C6035	TF C	ECQ-V50V-473J	1	374724734T
C6036	TF C	ECQ-V50V-473J	1	374724734T
C6040	UTSP C	CE04W50V 47M(UTSP)	1	397584707T
C6041	UTSP C	CE04W50V 47M(UTSP)	1	397584707T
C6042	UTSP C	CE04W50V 47M(UTSP)	1	397584707T
C6045	UTSP C	CE04W50V 47M(UTSP)	1	397584707T
C6046	UTSP C	CE04W50V 47M(UTSP)	1	397584707T
C6050	TF C	ECQ-V50V-103J	1	374721034T
C6051	TF C	ECQ-V50V-103J	1	374721034T
C6052	TF C	ECQ-V50V-103J	1	374721034T
C6055	TF C	ECQ-V50V-103J	1	374721034T
C6056	TF C	ECQ-V50V-103J	1	374721034T

C6076	MKT C	B32529C0102J289	1	376491024T	<EXCEPT MDC,MDD,MDF>
C6077	MKT C	B32529C0102J289	1	376491024T	<EXCEPT MDC,MDD,MDF>
C6086	TF C	ECQ-V50V-103J	1	374721034T	<EXCEPT MDC,MDD,MDF>
C6087	TF C	ECQ-V50V-103J	1	374721034T	<EXCEPT MDC,MDD,MDF>
C6630	C-CERA C	CK725F1E-104Z1	1	332161040R1	
C6701	UTSP C	CE04W25V-100M(UTSP)	1	397551017T	
C6703	C-CERA C	CK725F1H-104Z1	1	332151040R1	
C6704	UTSP C	CE04W50V-1M(UTSP)	1	397580107T	
C6706	UTSP C	CE04W50V-10M(UTSP)	1	397581007T	
C6713	C-CERA C	CK725F1E-104Z1	1	332161040R1	
C6714	UTSP C	CE04W50V-1M(UTSP)	1	397580107T	
C6901	ELECT C	CE69W63V-8200MB	1	3504420	
C6901A	IB CUSHION	W15*3t TAPE	1	28141585	
C6902	ELECT C	CE69W63V-8200MB	1	3504420	
C6902A	IB CUSHION	W15*3t TAPE	1	28141585	
C6911	C-CERA C	CC725CH1H-102J1	1	342101024R1	
C6912	TF C	ECQ-V50V-334J	1	374723344T	
C6913	TF C	ECQ-V50V-334J	1	374723344T	
C6915	TF C	ECQ-V50V-104J	1	374721044T	
C6916	TF C	ECQ-V50V-104J	1	374721044T	
C950	TF C	ECQ-V50V-104J	1	374721044T	
R5000	CARBON R	R16J-1K	1	417341024T	
R5001	CARBON R	R16J-1K	1	417341024T	
R5002	CARBON R	R16J-1K	1	417341024T	
R5005	CARBON R	R16J-1K	1	417341024T	
R5006	CARBON R	R16J-1K	1	417341024T	
R5010	CARBON R	R16J-56K	1	417345634T	
R5011	CARBON R	R16J-56K	1	417345634T	
R5012	CARBON R	R16J-56K	1	417345634T	
R5015	CARBON R	R16J-56K	1	417345634T	
R5016	CARBON R	R16J-56K	1	417345634T	
R5020	CARBON R	R16J-330	1	417343314T	
R5021	CARBON R	R16J-330	1	417343314T	

R5022	CARBON R	R16J-330	1	417343314T
R5025	CARBON R	R16J-330	1	417343314T
R5026	CARBON R	R16J-330	1	417343314T
R5030	CARBON R	R16J-120K	1	417341244T
R5031	CARBON R	R16J-120K	1	417341244T
R5032	CARBON R	R16J-120K	1	417341244T
R5035	CARBON R	R16J-120K	1	417341244T
R5036	CARBON R	R16J-120K	1	417341244T
R5040	CARBON R	R16J-2.2K	1	417342224T
R5041	CARBON R	R16J-2.2K	1	417342224T
R5042	CARBON R	R16J-2.2K	1	417342224T
R5045	CARBON R	R16J-2.2K	1	417342224T
R5046	CARBON R	R16J-2.2K	1	417342224T
R5050	CARBON R	R16J-4.7K	1	417344724T
R5051	CARBON R	R16J-4.7K	1	417344724T
R5052	CARBON R	R16J-4.7K	1	417344724T
R5055	CARBON R	R16J-4.7K	1	417344724T
R5056	CARBON R	R16J-4.7K	1	417344724T
R5060	CARBON R	R16J-1.2K	1	417341224T
R5061	CARBON R	R16J-1.2K	1	417341224T
R5062	CARBON R	R16J-1.2K	1	417341224T
R5065	CARBON R	R16J-1.2K	1	417341224T
R5066	CARBON R	R16J-1.2K	1	417341224T
R5080	CARBON R	R16J-470	1	417344714T
R5081	CARBON R	R16J-470	1	417344714T
R5082	CARBON R	R16J-470	1	417344714T
R5085	CARBON R	R16J-470	1	417344714T
R5086	CARBON R	R16J-470	1	417344714T
R5090	C-CARBON R	RN72K1J-104JE	1	435031044R1
R5091	C-CARBON R	RN72K1J-104JE	1	435031044R1
R5092	C-CARBON R	RN72K1J-104JE	1	435031044R1
R5095	C-CARBON R	RN72K1J-104JE	1	435031044R1
R5096	C-CARBON R	RN72K1J-104JE	1	435031044R1

R5100	C-CARBON R	RN72K1J-104JE	1	435031044R1
R5101	C-CARBON R	RN72K1J-104JE	1	435031044R1
R5102	C-CARBON R	RN72K1J-104JE	1	435031044R1
R5105	C-CARBON R	RN72K1J-104JE	1	435031044R1
R5106	C-CARBON R	RN72K1J-104JE	1	435031044R1
R5110	CARBON R	R16J-1K	1	417341024T
R5111	CARBON R	R16J-1K	1	417341024T
R5112	CARBON R	R16J-1K	1	417341024T
R5115	CARBON R	R16J-1K	1	417341024T
R5116	CARBON R	R16J-1K	1	417341024T
R5130	CARBON R	R16J-22K	1	417342234T
R5131	CARBON R	R16J-22K	1	417342234T
R5132	CARBON R	R16J-22K	1	417342234T
R5135	CARBON R	R16J-22K	1	417342234T
R5136	CARBON R	R16J-22K	1	417342234T
R5160	NF CARBON R	R25J-100	1	415471014T
R5161	NF CARBON R	R25J-100	1	415471014T
R5162	NF CARBON R	R25J-100	1	415471014T
R5165	NF CARBON R	R25J-100	1	415471014T
R5166	NF CARBON R	R25J-100	1	415471014T
R5170	NF CARBON R	R25J-100	1	415471014T
R5171	NF CARBON R	R25J-100	1	415471014T
R5172	NF CARBON R	R25J-100	1	415471014T
R5175	NF CARBON R	R25J-100	1	415471014T
R5176	NF CARBON R	R25J-100	1	415471014T
R5180	NF CARBON R	R25J-10	1	415471004T
R5181	NF CARBON R	R25J-10	1	415471004T
R5182	NF CARBON R	R25J-10	1	415471004T
R5185	NF CARBON R	R25J-10	1	415471004T
R5186	NF CARBON R	R25J-10	1	415471004T
R5190	NF CARBON R	R25J-10	1	415471004T
R5191	NF CARBON R	R25J-10	1	415471004T
R5192	NF CARBON R	R25J-10	1	415471004T

R5195	NF CARBON R	R25J-10	1	415471004T
R5196	NF CARBON R	R25J-10	1	415471004T
R5200	CARBON R	R16J-22K	1	417342234T
R5201	CARBON R	R16J-22K	1	417342234T
R5202	CARBON R	R16J-22K	1	417342234T
R5205	CARBON R	R16J-22K	1	417342234T
R5206	CARBON R	R16J-22K	1	417342234T
R5230	CARBON R	R16J-120K	1	417341244T
R5231	CARBON R	R16J-120K	1	417341244T
R5232	CARBON R	R16J-120K	1	417341244T
R5235	CARBON R	R16J-120K	1	417341244T
R5236	CARBON R	R16J-120K	1	417341244T
R5301	C-CARBON R	RN72K1J-000JE	1	435030004R1
R5302	C-CARBON R	RN72K1J-000JE	1	435030004R1
R5303	C-CARBON R	RN72K1J-000JE	1	435030004R1
R5304	C-CARBON R	RN72K1J-000JE	1	435030004R1
R5305	C-CARBON R	RN72K1J-000JE	1	435030004R1
R5306	C-CARBON R	RN72K1J-000JE	1	435030004R1
R5307	C-CARBON R	RN72K1J-000JE	1	435030004R1
R5308	C-CARBON R	RN72K1J-000JE	1	435030004R1
R5309	C-CARBON R	RN72K1J-000JE	1	435030004R1
R5310	C-CARBON R	RN72K1J-000JE	1	435030004R1
R5311	C-CARBON R	RN72K1J-000JE	1	435030004R1
R5312	C-CARBON R	RN72K1J-000JE	1	435030004R1
R5313	C-CARBON R	RN72K1J-000JE	1	435030004R1
R5314	C-CARBON R	RN72K1J-000JE	1	435030004R1
R5315	C-CARBON R	RN72K1J-000JE	1	435030004R1
R5316	C-CARBON R	RN72K1J-000JE	1	435030004R1
R5317	C-CARBON R	RN72K1J-000JE	1	435030004R1
R5318	C-CARBON R	RN72K1J-000JE	1	435030004R1
R5319	C-CARBON R	RN72K1J-000JE	1	435030004R1
R5500	C-CARBON R	RN72K1J-331JE	1	435033314R1
R5503	C-CARBON R	RN72K1J-331JE	1	435033314R1

R5504	C-CARBON R	RN72K1J-331JE	1	435033314R1
R5505	C-CARBON R	RN72K1J-222JE	1	435032224R1
R5506	C-CARBON R	RN72K1J-222JE	1	435032224R1
R5507	C-CARBON R	RN72K1J-331JE	1	435033314R1
R5508	C-CARBON R	RN72K1J-331JE	1	435033314R1
R5513	C-CARBON R	RN72K1J-331JE	1	435033314R1
R5514	C-CARBON R	RN72K1J-331JE	1	435033314R1
R5515	C-CARBON R	RN72K1J-222JE	1	435032224R1
R5516	C-CARBON R	RN72K1J-222JE	1	435032224R1
R5517	C-CARBON R	RN72K1J-331JE	1	435033314R1
R5518	C-CARBON R	RN72K1J-331JE	1	435033314R1
R5519	C-CARBON R	RN72K1J-331JE	1	435033314R1
R5520	C-CARBON R	RN72K1J-331JE	1	435033314R1
R5528	C-CARBON R	RN72K1J-101JE	1	435031014R1
R5530	C-CARBON R	RN72K1J-331JE	1	435033314R1
R5531	C-CARBON R	RN72K1J-331JE	1	435033314R1
R5535	C-CARBON R	RN72K1J-101JE	1	435031014R1
R5536	C-CARBON R	RN72K1J-101JE	1	435031014R1
R5543	C-CARBON R	RN72K1J-104JE	1	435031044R1
R5544	C-CARBON R	RN72K1J-104JE	1	435031044R1
R5545	C-CARBON R	RN72K1J-224JE	1	435032244R1
R5546	C-CARBON R	RN72K1J-224JE	1	435032244R1
R5547	C-CARBON R	RN72K1J-104JE	1	435031044R1
R5548	C-CARBON R	RN72K1J-104JE	1	435031044R1
R5553	C-CARBON R	RN72K1J-104JE	1	435031044R1
R5554	C-CARBON R	RN72K1J-104JE	1	435031044R1
R5555	C-CARBON R	RN72K1J-224JE	1	435032244R1
R5556	C-CARBON R	RN72K1J-224JE	1	435032244R1
R5557	C-CARBON R	RN72K1J-104JE	1	435031044R1
R5558	C-CARBON R	RN72K1J-104JE	1	435031044R1
R5559	C-CARBON R	RN72K1J-104JE	1	435031044R1
R5560	C-CARBON R	RN72K1J-104JE	1	435031044R1
R5567	C-CARBON R	RN72K1J-473JE	1	435034734R1

R5568	C-CARBON R	RN72K1J-473JE	1	435034734R1
R5569	C-CARBON R	RN72K1J-224JE	1	435032244R1
R5570	C-CARBON R	RN72K1J-222JE	1	435032224R1
R5571	C-CARBON R	RN72K1J-222JE	1	435032224R1
R5575	C-CARBON R	RN72K1J-224JE	1	435032244R1
R5576	C-CARBON R	RN72K1J-224JE	1	435032244R1
R5577	C-CARBON R	RN72K1J-223JE	1	435032234R1
R5578	C-CARBON R	RN72K1J-473JE	1	435034734R1
R5579	C-CARBON R	RN72K1J-473JE	1	435034734R1
R5580	C-CARBON R	RN72K1J-104JE	1	435031044R1
R5581	C-CARBON R	RN72K1J-104JE	1	435031044R1
R5582	C-CARBON R	RN72K1J-104JE	1	435031044R1
R5585	C-CARBON R	RN72K1J-182JE	1	435031824R1
R5586	C-CARBON R	RN72K1J-182JE	1	435031824R1
R5587	C-CARBON R	RN72K1J-103JE	1	435031034R1
R5588	C-CARBON R	RN72K1J-103JE	1	435031034R1
R5589	C-CARBON R	RN72K1J-000JE	1	435030004R1
R5590	C-CARBON R	RN72K1J-103JE	1	435031034R1
R5591	C-CARBON R	RN72K1J-103JE	1	435031034R1
R5592	C-CARBON R	RN72K1J-471JE	1	435034714R1
R5593	C-CARBON R	RN72K1J-122JE	1	435031224R1
R5594	C-CARBON R	RN72K1J-103JE	1	435031034R1
R5595	C-CARBON R	RN72K1J-103JE	1	435031034R1
R5596	C-CARBON R	RN72K1J-471JE	1	435034714R1
R5597	C-CARBON R	RN72K1J-122JE	1	435031224R1
R5598	C-CARBON R	RN72K1J-103JE	1	435031034R1
R5599	C-CARBON R	RN72K1J-103JE	1	435031034R1
R5600	C-CARBON R	RN72K1J-224JE	1	435032244R1
R5601	C-CARBON R	RN72K1J-224JE	1	435032244R1
R5602	C-CARBON R	RN72K1J-224JE	1	435032244R1
R5603	C-CARBON R	RN72K1J-224JE	1	435032244R1
R5604	C-CARBON R	RN72K1J-224JE	1	435032244R1
R5605	C-CARBON R	RN72K1J-224JE	1	435032244R1

R5606	C-CARBON R	RN72K1J-224JE	1	435032244R1
R5607	C-CARBON R	RN72K1J-224JE	1	435032244R1
R5608	C-CARBON R	RN72K1J-224JE	1	435032244R1
R5609	C-CARBON R	RN72K1J-224JE	1	435032244R1
R5610	C-CARBON R	RN72K1J-222JE	1	435032224R1
R5611	C-CARBON R	RN72K1J-222JE	1	435032224R1
R5612	C-CARBON R	RN72K1J-222JE	1	435032224R1
R5613	C-CARBON R	RN72K1J-271JE	1	435032714R1
R5614	C-CARBON R	RN72K1J-271JE	1	435032714R1
R5615	C-CARBON R	RN72K1J-222JE	1	435032224R1
R5616	C-CARBON R	RN72K1J-222JE	1	435032224R1
R5617	C-CARBON R	RN72K1J-271JE	1	435032714R1
R5618	C-CARBON R	RN72K1J-222JE	1	435032224R1
R5619	C-CARBON R	RN72K1J-222JE	1	435032224R1
R5620	C-CARBON R	RN72K1J-000JE	1	435030004R1
R5621	C-CARBON R	RN72K1J-000JE	1	435030004R1
R5622	C-CARBON R	RN72K1J-000JE	1	435030004R1
R5623	C-CARBON R	RN72K1J-101JE	1	435031014R1
R5624	C-CARBON R	RN72K1J-101JE	1	435031014R1
R5625	C-CARBON R	RN72K1J-000JE	1	435030004R1
R5626	C-CARBON R	RN72K1J-000JE	1	435030004R1
R5627	C-CARBON R	RN72K1J-101JE	1	435031014R1
R5630	C-CARBON R	RN72K1J-221JE	1	435032214R1
R5631	C-CARBON R	RN72K1J-473JE	1	435034734R1
R5632	C-CARBON R	RN72K1J-153JE	1	435031534R1
R5633	C-CARBON R	RN72K1J-122JE	1	435031224R1
R5634	C-CARBON R	RN72K1J-103JE	1	435031034R1
R5660	METAL R	RNU1WCJ-0.22	1	453632294T
R5661	METAL R	RNU1WCJ-0.22	1	453632294T
R5666	CARBON R	R16J-22	1	417342204T
R5667	CARBON R	R16J-22	1	417342204T
R5670	METAL O R	RS2WBJ-10	1	441721004F
R5671	METAL O R	RS2WBJ-27	1	441722704F

R5672	METAL O R	RS2WBJ-10	1	441721004F
R5673	METAL O R	RS2WBJ-27	1	441722704F
R5674	METAL O R	RS1WBJ-68	1	443626804T
R5675	METAL O R	RS1WBJ-68	1	443626804T
R5676	METAL O R	RS1WBJ-68	1	443626804T
R5677	METAL O R	RS1WBJ-68	1	443626804T
R5680	C-CARBON R	RN72K1J-224JE	1	435032244R1
R5681	C-CARBON R	RN72K1J-224JE	1	435032244R1
R5682	C-CARBON R	RN72K1J-224JE	1	435032244R1
R5683	C-CARBON R	RN72K1J-224JE	1	435032244R1
R5689	C-CARBON R	RN72K1J-224JE	1	435032244R1
R5690	C-CARBON R	RN72K1J-224JE	1	435032244R1
R5692	C-CARBON R	RN72K1J-224JE	1	435032244R1
R5693	C-CARBON R	RN72K1J-224JE	1	435032244R1
R5694	C-CARBON R	RN72K1J-224JE	1	435032244R1
R5695	C-CARBON R	RN72K1J-224JE	1	435032244R1
R5696	C-CARBON R	RN72K1J-224JE	1	435032244R1
R5708	C-CARBON R	RN72K1J-000JE	1	435030004R1
R5709	C-CARBON R	RN72K1J-000JE	1	435030004R1
R5711	C-CARBON R	RN72K1J-000JE	1	435030004R1
R5712	C-CARBON R	RN72K1J-000JE	1	435030004R1
R5735	C-CARBON R	RN72K1J-000JE	1	435030004R1
R5802	C-CARBON R	RN72K1J-512JE	1	435035124R1
R5803	C-CARBON R	RN72K1J-512JE	1	435035124R1
R5804	C-CARBON R	RN72K1J-512JE	1	435035124R1
R5805	C-CARBON R	RN72K1J-512JE	1	435035124R1
R5806	C-CARBON R	RN72K1J-512JE	1	435035124R1
R5807	C-CARBON R	RN72K1J-512JE	1	435035124R1
R5811	C-CARBON R	RN72K1J-000JE	1	435030004R1
R5812	C-CARBON R	RN72K1J-000JE	1	435030004R1
R5813	C-CARBON R	RN72K1J-000JE	1	435030004R1
R5814	C-CARBON R	RN72K1J-000JE	1	435030004R1
R6000	C-CARBON R	RN72K1J-562JE	1	435035624R1

R6001	C-CARBON R	RN72K1J-562JE	1	435035624R1
R6002	C-CARBON R	RN72K1J-562JE	1	435035624R1
R6005	C-CARBON R	RN72K1J-562JE	1	435035624R1
R6006	C-CARBON R	RN72K1J-562JE	1	435035624R1
R6010	C-CARBON R	RN72K1J-392JE	1	435033924R1
R6011	C-CARBON R	RN72K1J-392JE	1	435033924R1
R6012	C-CARBON R	RN72K1J-392JE	1	435033924R1
R6015	C-CARBON R	RN72K1J-392JE	1	435033924R1
R6016	C-CARBON R	RN72K1J-392JE	1	435033924R1
R6020	NF CARBON R	R25J-2.2	1	415470224T
R6021	NF CARBON R	R25J-2.2	1	415470224T
R6022	NF CARBON R	R25J-2.2	1	415470224T
R6025	NF CARBON R	R25J-2.2	1	415470224T
R6026	NF CARBON R	R25J-2.2	1	415470224T
R6030	CARBON R	R16J-470	1	417344714T
R6031	CARBON R	R16J-470	1	417344714T
R6032	CARBON R	R16J-470	1	417344714T
R6035	CARBON R	R16J-470	1	417344714T
R6036	CARBON R	R16J-470	1	417344714T
R6040	TRIM R	N06HR2KBC	1	5210390T
R6041	TRIM R	N06HR2KBC	1	5210390T
R6042	TRIM R	N06HR2KBC	1	5210390T
R6045	TRIM R	N06HR2KBC	1	5210390T
R6046	TRIM R	N06HR2KBC	1	5210390T
R6050	C-CARBON R	RN72K1J-332JE	1	435033324R1
R6051	C-CARBON R	RN72K1J-332JE	1	435033324R1
R6052	C-CARBON R	RN72K1J-332JE	1	435033324R1
R6055	C-CARBON R	RN72K1J-332JE	1	435033324R1
R6056	C-CARBON R	RN72K1J-332JE	1	435033324R1
R6070	NF CARBON R	R25J-100	1	415471014T
R6071	NF CARBON R	R25J-100	1	415471014T
R6072	NF CARBON R	R25J-100	1	415471014T
R6075	NF CARBON R	R25J-100	1	415471014T

R6076	NF CARBON R	R25J-100	1	415471014T
R6080	NF CARBON R	R25J-0.22	1	415472294T
R6081	NF CARBON R	R25J-0.22	1	415472294T
R6082	NF CARBON R	R25J-0.22	1	415472294T
R6085	NF CARBON R	R25J-0.22	1	415472294T
R6086	NF CARBON R	R25J-0.22	1	415472294T
R6090	NF CARBON R	R25J-0.22	1	415472294T
R6091	NF CARBON R	R25J-0.22	1	415472294T
R6092	NF CARBON R	R25J-0.22	1	415472294T
R6095	NF CARBON R	R25J-0.22	1	415472294T
R6096	NF CARBON R	R25J-0.22	1	415472294T
R6100	METAL PR	MPR2W+2W 0R22	1	4000234
R6101	METAL PR	MPR2W+2W 0R22	1	4000234
R6102	METAL PR	MPR2W+2W 0R22	1	4000234
R6105	METAL PR	MPR2W+2W 0R22	1	4000234
R6106	METAL PR	MPR2W+2W 0R22	1	4000234
R6130	METAL R	RNU1WCJ-8.2	1	453630824T
R6131	METAL R	RNU1WCJ-8.2	1	453630824T
R6132	METAL R	RNU1WCJ-8.2	1	453630824T
R6135	METAL R	RNU1WCJ-8.2	1	453630824T
R6136	METAL R	RNU1WCJ-8.2	1	453630824T
R6140	C-CARBON R	RN72K1J-563JE	1	435035634R1
R6141	C-CARBON R	RN72K1J-563JE	1	435035634R1
R6142	C-CARBON R	RN72K1J-563JE	1	435035634R1
R6145	C-CARBON R	RN72K1J-563JE	1	435035634R1
R6146	C-CARBON R	RN72K1J-563JE	1	435035634R1
R6150	C-CARBON R	RN72K1J-103JE	1	435031034R1
R6151	C-CARBON R	RN72K1J-103JE	1	435031034R1
R6152	C-CARBON R	RN72K1J-103JE	1	435031034R1
R6155	C-CARBON R	RN72K1J-103JE	1	435031034R1
R6156	C-CARBON R	RN72K1J-103JE	1	435031034R1
R6160	C-CARBON R	RN72K1J-333JE	1	435033334R1
R6161	C-CARBON R	RN72K1J-333JE	1	435033334R1

R6162	C-CARBON R	RN72K1J-333JE	1	435033334R1	
R6165	C-CARBON R	RN72K1J-333JE	1	435033334R1	
R6166	C-CARBON R	RN72K1J-333JE	1	435033334R1	
R6170	C-CARBON R	RN72K1J-473JE	1	435034734R1	
R6171	C-CARBON R	RN72K1J-473JE	1	435034734R1	
R6172	C-CARBON R	RN72K1J-473JE	1	435034734R1	
R6175	C-CARBON R	RN72K1J-473JE	1	435034734R1	
R6176	C-CARBON R	RN72K1J-473JE	1	435034734R1	
R6180	C-CARBON R	RN72K1J-473JE	1	435034734R1	
R6181	C-CARBON R	RN72K1J-473JE	1	435034734R1	
R6182	C-CARBON R	RN72K1J-473JE	1	435034734R1	
R6185	C-CARBON R	RN72K1J-473JE	1	435034734R1	
R6186	C-CARBON R	RN72K1J-473JE	1	435034734R1	
R6197	METAL R	RNU1WCJ-8.2	1	453630824T	
R6701	CARBON R	R16J-22K	1	417342234T	
R6702	C-CARBON R	RN72K1J-103JE	1	435031034R1	
R6704	C-CARBON R	RN72K1J-473JE	1	435034734R1	
R6706	C-CARBON R	RN72K1J-224JE	1	435032244R1	
R6708	C-CARBON R	RN72K1J-333JE	1	435033334R1	
R6709	C-CARBON R	RN72K1J-562JE	1	435035624R1	
R6710	C-CARBON R	RN72K1J-562JE	1	435035624R1	
R6712	C-CARBON R	RN72K1J-103JE	1	435031034R1	
R6714	C-CARBON R	RN72K1J-473JE	1	435034734R1	
R6716	C-CARBON R	RN72K1J-224JE	1	435032244R1	
R6902	C-CARBON R	RN72K1J-102JE	1	435031024R1	
R6903	C-CARBON R	RN72K1J-473JE	1	435034734R1	
R950	METAL R	RNU1/2WCJ-8.2	1	453530824T	!
R951	METAL R	RNU1/2WCJ-0.1	1	453531094T	! <MDC,MDD,MDF>
R951	METAL R	RNU1/2WCJ-0.22	1	453532294T	! <EXCEPT MDC,MDD,MDF>
F6901C	FUSE HOL	NSCT-1P2031	1	25052133T	
F6901D	FUSE HOL	NSCT-1P2031	1	25052133T	
F6902C	FUSE HOL	NSCT-1P2031	1	25052133T	
F6902D	FUSE HOL	NSCT-1P2031	1	25052133T	

JL5501A	WIRE HOL	NSCT-3P874	1	25051087	
JL5502A	WIRE HOL	NSCT-5P876	1	25051089	
JL6600A	WIRE HOL	NSCT-7P898	1	25051111	
JL6603A	WIRE HOL	NSCT-9P900	1	25051113	
JL6604A	WIRE HOL	NSCT-5P896	1	25051109	
JL6952A	WIRE HOL	NSCT-5P896	1	25051109	
JL6952B	WIRE HOL	NSCT-5P896	1	25051109	
JL9101A	WIRE HOL	NSCT-7P898	1	25051111	
P001	PWB	BCAF-0008	1	25140008B	N
P5501B	PLUG	NPLG-7P0962	1	25056012	
P5502B	PLUG	NPLG-15P0970	1	25056020	
P5503B	PLUG	NPLG-9P0964	1	25056014	
P5504B	PLUG	NPLG-7P0962	1	25056012	
P6080	PLUG	NPLG-2P29	1	25055038	
P6081	PLUG	NPLG-2P29	1	25055038	
P6082	PLUG	NPLG-2P29	1	25055038	
P6085	PLUG	NPLG-2P29	1	25055038	
P6086	PLUG	NPLG-2P29	1	25055038	
P6102	HOLDER	(CRAMP) UA-0 V0	1	27190608-1	
P6602	TRM	NTM-4PDML422	1	25060494	
P6604	WS CLAMP	CB-71683(L=50)	1	260261	
P6900	CRIMP AS	CRIMP AS	1	20799165UL	
P6901	CRIMP AS	CRIMP AS	1	2069925202UL	
P6902	CRIMP AS	CRIMP AS	1	2069925189UL	
P6903	CRIMP AS	UL1015#18SIN-SVH 200 YEL	1	20799172UL	
P6904	CRIMP AS	CRIMP AS	1	20799164UL	
P6911A	RETAINER	(BUS)	1	27142022	
P6991	TRM-423(SCREW)	NEJITANSI ST3	1	25060495	
P7900	ST JACK	MSJ-035-22	1	25045887	
P7900 or	JACK	YKB21-5130	(1)	25045387	
P7902	PIN JACK	NPJ-2PDWR595	1	25045815	
P7903	PIN JACK	NPJ-4PDWWR624	1	25045845	
P7903 or	PIN JACK	NPJ-4PDBL162	(1)	25045303	

P7907	PIN JACK	NPJ-4PDWRR624	1	25045845	
P7907 or	PIN JACK	NPJ-4PDBL162	(1)	25045303	
P7908	PIN JACK	NPJ-4PDWRR624	1	25045845	
P7908 or	PIN JACK	NPJ-4PDBL162	(1)	25045303	
P7909	PIN JACK	NPJ-4PDWRNT684	1	25045916	N
P7910	PIN JACK	NPJ-1PDP555	1	25045773	
RL6901	RELAY	NRL-1P10A-DC12-140	1	25065584	
RL6901 or	RELAY	NRL-1P10A-DC12-143	(1)	25065588	
RL6902	RELAY	NRL-1P10A-DC12-140	1	25065584	
RL6902 or	RELAY	NRL-1P10A-DC12-143	(1)	25065588	

U002 MPU/CODEC pc board AS (BADG-0025-1A/1B/1C)
U0021 Universal port pc board AS (BAETC-0027-1A/1B/1C)

CIRCUIT NO.	PART NAME	DESCRIPTION	Q'TY	PART NO. (SN)	REMARKS
U131	PHT CP	JSR1165-001recieving	1	24120143	
U131 or	PHT CP	GP1FAV51RK0F	(1)	24120129	
U132	PHT CP	JSR1165-001recieving	1	24120143	
U132 or	PHT CP	GP1FAV51RK0F	(1)	24120129	
D110	C-DIODE	KDS4148U	1	223283R2	
D110 or	C-DIODE	1SS352	(1)	223234R2	
D110 or	C-DIODE	MA2J111	(1)	223279R2	
D111	C-DIODE	KDS4148U	1	223283R2	
D111 or	C-DIODE	1SS352	(1)	223234R2	
D111 or	C-DIODE	MA2J111	(1)	223279R2	
D112	ZENER D	UDZS10B	1	224551000R2	
D131	C-DIODE	KDS4148U	1	223283R2	
D131 or	C-DIODE	1SS352	(1)	223234R2	
D131 or	C-DIODE	MA2J111	(1)	223279R2	
D132	C-DIODE	KDS4148U	1	223283R2	
D132 or	C-DIODE	1SS352	(1)	223234R2	
D132 or	C-DIODE	MA2J111	(1)	223279R2	
D181	C-DIODE	KDS4148U	1	223283R2	

D181 or	C-DIODE	1SS352	(1)	223234R2	
D181 or	C-DIODE	MA2J111	(1)	223279R2	
D182	C-DIODE	KDS4148U	1	223283R2	
D182 or	C-DIODE	1SS352	(1)	223234R2	
D182 or	C-DIODE	MA2J111	(1)	223279R2	
D183	DIODE	RL1N4003	1	22380260T	
D601	C-DIODE	KDS4148U	1	223283R2	
D601 or	C-DIODE	1SS352	(1)	223234R2	
D601 or	C-DIODE	MA2J111	(1)	223279R2	
D701	C-DIODE	KDS4148U	1	223283R2	
D701 or	C-DIODE	1SS352	(1)	223234R2	
D701 or	C-DIODE	MA2J111	(1)	223279R2	
D702	C-DIODE	KDS4148U	1	223283R2	
D702 or	C-DIODE	1SS352	(1)	223234R2	
D702 or	C-DIODE	MA2J111	(1)	223279R2	
Q101	IC	LC72725KV-TLM-E	1	22242584R2	<MPB,MPP>
Q111	TR	2SC2235-Y(TPE6_F)	1	2211654T	
Q131	IC	74HCU04F	1	222740046R2	
Q131 or	IC	TC74HCU04AF	(1)	222740046R2TO	
Q153	IC	R1EX25064ASA00A	1	22242581R2	N
Q171	IC	TC7WU04FU(TE12L_F)	1	22240935R2	
Q181	TR	KRC105S	1	2217290R2	
Q181 or	TR	RN1405	(1)	2214500R2	
Q301	IC	CS42518-CQZR-D	1	22242229R2	
Q302	IC	TC74VHC157FT	1	22274157ER2TO	
Q400	IC	NJM4580M-D	1	22241448R2	
Q401	IC	NJM4580M-D	1	22241448R2	
Q402	IC	NJM4580M-D	1	22241448R2	
Q403	IC	NJM4580M-D	1	22241448R2	
Q404	IC	NJM4580M-D	1	22241448R2	
Q601	TR	KRC104S	1	2216210R2	
Q601 or	TR	RN1404	(1)	2214490R2	
Q701	IC (MAIN MICROPROCESSOR)	MPD70F3746GJ-GAE-AX(0301)	1	222W0079R303010	

Q702	IC	S-812C33AUA-C2N	1	22242222R2
Q703	IC	S-812C56AUA-C3K	1	22242207R2
Q746	IC	BH33FB1WG-TR	1	22242585R2
Q751	TR	KRC104S	1	2216210R2
Q751 or	TR	RN1404	(1)	2214490R2
Q752	TR	KRA102S	1	2216220R2
Q752 or	TR	RN2402	(1)	2214530R2
Q753	TR	KRA107S	1	2216350R2
Q753 or	TR	RN2407(TE85L_F)	(1)	2216360R2
Q754	TR	KRC102S	1	2216190R2
Q754 or	TR	RN1402	(1)	2214470R2
Q755	TR	KRA107S	1	2216350R2
Q755 or	TR	RN2407(TE85L_F)	(1)	2216360R2
Q756	TR	KRC102S	1	2216190R2
Q756 or	TR	RN1402	(1)	2214470R2
Q757	TR	KRC107S	1	2216340R2
Q757 or	TR	RN1407	(1)	2216260R2
Q761	TR	KRC104S	1	2216210R2
Q761 or	TR	RN1404	(1)	2214490R2
Q762	TR	KRA102S	1	2216220R2
Q762 or	TR	RN2402	(1)	2214530R2
Q771	TR	KRC104S	1	2216210R2
Q771 or	TR	RN1404	(1)	2214490R2
Q772	TR	KRA102S	1	2216220R2
Q772 or	TR	RN2402	(1)	2214530R2
Q781	TR	KRC104S	1	2216210R2
Q781 or	TR	RN1404	(1)	2214490R2
Q782	TR	KRA102S	1	2216220R2
Q782 or	TR	RN2402	(1)	2214530R2
L101	CORE	BLM18PG181SN1D	1	2350005R1
L131	CHOKE COIL	LBC2518T2R2M	1	231364M022R2
L132	CHOKE COIL	LBC2518T2R2M	1	231364M022R2
L133	CHOKE COIL	LBC2518T470M	1	231364M470R2

L134	CHOKE COIL	LBC2518T470M	1	231364M470R2
L153	CORE	BLM18PG181SN1D	1	2350005R1
L171	CHOKE COIL	LBC2518T470M	1	231364M470R2
L173	EMIFIL	BK1608LM182-T	1	230958R1
L2100	CORE	BLM18PG181SN1D	1	2350005R1
L2101	CORE	BLM18PG181SN1D	1	2350005R1
L2102	CORE	BLM18PG181SN1D	1	2350005R1
L2103	EMIFIL	BK1608LM182-T	1	230958R1
L2104	EMIFIL	BK1608LM182-T	1	230958R1
L2105	EMIFIL	BK1608LM182-T	1	230958R1
L2106	EMIFIL	BK1608LM182-T	1	230958R1
L2107	EMIFIL	BK1608LM182-T	1	230958R1
L2108	EMIFIL	BK1608LM182-T	1	230958R1
L2109	EMIFIL	BK1608LM182-T	1	230958R1
L2110	EMIFIL	BK1608LM182-T	1	230958R1
L2111	EMIFIL	BK1608LM182-T	1	230958R1
L2112	EMIFIL	BK1608LM182-T	1	230958R1
L2113	EMIFIL	BK1608LM182-T	1	230958R1
L2114	EMIFIL	BK1608LM182-T	1	230958R1
L2115	EMIFIL	BK1608LM182-T	1	230958R1
L301	CHOKE COIL	BLM21PG221SN1	1	230949R2
L302	CORE	BLM18PG181SN1D	1	2350005R1
L303	CHOKE COIL	LBC2518T4R7M	1	231364M047R2
L304	CHOKE COIL	BLM21PG221SN1	1	230949R2
L305	CORE	BLM18PG181SN1D	1	2350005R1
L306	CHOKE COIL	LBC2518T4R7M	1	231364M047R2
L307	CHOKE COIL	LBC2518T4R7M	1	231364M047R2
L311	EMIFIL	BK1608LM182-T	1	230958R1
L313	EMIFIL	BK1608LM182-T	1	230958R1
L322	EMIFIL	BK1608LM182-T	1	230958R1
L500	CORE	BLM18PG181SN1D	1	2350005R1
L741	CORE	BLM18PG181SN1D	1	2350005R1
L742	CHOKE COIL	BLM21PG221SN1	1	230949R2

L743	CORE	BLM18PG181SN1D	1	2350005R1	
L744	CORE	BLM18PG181SN1D	1	2350005R1	
L746	CORE	BLM18PG181SN1D	1	2350005R1	
L747	CORE	BLM18PG181SN1D	1	2350005R1	
C101	UTSP C	CE04W25V-100M(UTSP)	1	397551017T	
C102	C-CERA C	CK725F1E-104Z1	1	332161040R1	
C103	UTSP C	CE04W50V-10M(UTSP)	1	397581007T	<MPB,MPP>
C104	UTSP C	CE04W50V-10M(UTSP)	1	397581007T	<MPB,MPP>
C105	C-CERA C	CK725F1E-104Z1	1	332161040R1	<MPB,MPP>
C106	C-CERA C	CC725CH1H-331J1	1	342103314R1	<MPB,MPP>
C107	C-CERA C	CK725F1E-104Z1	1	332161040R1	<MPB,MPP>
C108	C-CERA C	CC725CH1H-150J1	1	342101504R1	<MPB,MPP>
C109	C-CERA C	CC725CH1H-150J1	1	342101504R1	<MPB,MPP>
C110	C-CERA C	CC725CH1H-331J1	1	342103314R1	<MPB,MPP>
C111	UTSP C	CE04W50V 47M(UTSP)	1	397584707T	
C112	C-CERA C	CK725F1E-104Z1	1	332161040R1	
C113	C-CERA C	CC725CH1H-221J1	1	342102214R1	<MPB,MPP>
C130	C-CERA C	CK725F1E-104Z1	1	332161040R1	
C131	C-CERA C	CC725CH1H-101J1	1	342101014R1	
C132	C-CERA C	CC725CH1H-101J1	1	342101014R1	
C133	C-CERA C	CK725B1C-104K1	1	332121045R1	
C134	C-CERA C	CK725B1C-104K1	1	332121045R1	
C135	C-CERA C	CC725CH1H-080D1	1	342100802R1	
C136	C-CERA C	CC725CH1H-080D1	1	342100802R1	
C139	UTSP C	CE04W10V-220M(UTSP)	1	397532217T	
C140	C-CERA C	CK725F1E-104Z1	1	332161040R1	
C141	C-CERA C	CK725F1E-104Z1	1	332161040R1	
C142	C-CERA C	CK725F1E-104Z1	1	332161040R1	
C145	UTSP C	CE04W10V-220M(UTSP)	1	397532217T	
C151	C-CERA C	CK725F1E-104Z1	1	332161040R1	
C171	C-CERA C	CK725F1E-104Z1	1	332161040R1	
C172	C-CERA C	CC725CH1H-100D1	1	342101002R1	
C173	C-CERA C	CC725CH1H-100D1	1	342101002R1	

C2150	C-CERA C	CC725CH1H-471J1	1	342104714R1
C2151	C-CERA C	CC725CH1H-471J1	1	342104714R1
C2152	C-CERA C	CC725CH1H-470J1	1	342104704R1
C2155	C-CERA C	CK725F1E-104Z1	1	332161040R1
C300	UTSP C	CE04W10V-470M(UTSP)	1	397534717T
C301	C-CERA C	CK725B1H-103K1	1	332101035R1
C302	UTSP C	CE04W10V-470M(UTSP)	1	397534717T
C303	UTSP C	CE04W10V-470M(UTSP)	1	397534717T
C304	UTSP C	CE04W10V-470M(UTSP)	1	397534717T
C305	C-CERA C	CK725F1E-104Z1	1	332161040R1
C306	UTSJ C	CE04W25V-47M(UTSJ)	1	398054707T
C307	C-CERA C	CK725F1E-104Z1	1	332161040R1
C308	UTSP C	CE04W25V-100M(UTSP)	1	397551017T
C309	C-CERA C	CK725F1E-104Z1	1	332161040R1
C310	C-CERA C	CC725CH1H-102J1	1	342101024R1
C311	C-CERA C	CK725B1H-223K1	1	332102235R1
C312	C-CERA C	CK725F1E-104Z1	1	332161040R1
C313	C-CERA C	CK725F1E-104Z1	1	332161040R1
C314	C-CERA C	CK725F1E-104Z1	1	332161040R1
C315	C-CERA C	CK725F1E-104Z1	1	332161040R1
C316	C-CERA C	CC725CH1H-221J1	1	342102214R1
C317	C-CERA C	CK725F1E-104Z1	1	332161040R1
C318	C-CERA C	CK725F1E-104Z1	1	332161040R1
C319	C-CERA C	CK725F1E-104Z1	1	332161040R1
C320	UTSP C	CE04W50V 47M(UTSP)	1	397584707T
C321	UTSP C	CE04W50V 47M(UTSP)	1	397584707T
C322	C-CERA C	CK725F1E-104Z1	1	332161040R1
C330	UTSP C	CE04W50V 47M(UTSP)	1	397584707T
C331	UTSP C	CE04W50V 47M(UTSP)	1	397584707T
C333	C-CERA C	CC725CH1H-330J1	1	342103304R1
C334	C-CERA C	CC725CH1H-330J1	1	342103304R1
C336	C-CERA C	CC725CH1H-330J1	1	342103304R1
C337	C-CERA C	CC725CH1H-330J1	1	342103304R1

C340	C-CERA C	CC732CH1H-222J	1	347342224R2	
C341	C-CERA C	CC732CH1H-222J	1	347342224R2	
C350	C-CERA C	CC725CH1H-101J1	1	342101014R1	
C351	C-CERA C	CC725CH1H-101J1	1	342101014R1	
C400	MKT C	B32529C0222J289	1	376492224T	
C401	MKT C	B32529C0222J289	1	376492224T	
C402	MKT C	B32529C0222J289	1	376492224T	
C403	MKT C	B32529C0222J289	1	376492224T	
C404	MKT C	B32529C0222J289	1	376492224T	
C405	MKT C	B32529C0222J289	1	376492224T	
C406	MKT C	B32529C0222J289	1	376492224T	
C407	TF C	ECQ-V50V-333J	1	374723334T	
C408	UTSP C	CE04W25V-220M(UTSP)	1	397552217T	
C409	UTSP C	CE04W25V-220M(UTSP)	1	397552217T	
C410	UPZ C	2AUPZTF331JE	1	376333314T	N
C411	UPZ C	2AUPZTF331JE	1	376333314T	N
C412	UPZ C	2AUPZTF331JE	1	376333314T	N
C413	C-CERA C	CC725CH1H-331J1	1	342103314R1	
C414	C-CERA C	CC725CH1H-331J1	1	342103314R1	
C415	C-CERA C	CC725CH1H-331J1	1	342103314R1	
C416	C-CERA C	CC725CH1H-331J1	1	342103314R1	
C417	TF C	ECQ-V50V-333J	1	374723334T	
C420	UPZ C	2AUPZTF331JE	1	376333314T	N
C421	UPZ C	2AUPZTF331JE	1	376333314T	N
C422	UPZ C	2AUPZTF331JE	1	376333314T	N
C423	C-CERA C	CC725CH1H-331J1	1	342103314R1	
C424	C-CERA C	CC725CH1H-331J1	1	342103314R1	
C425	C-CERA C	CC725CH1H-331J1	1	342103314R1	
C426	C-CERA C	CC725CH1H-331J1	1	342103314R1	
C427	TF C	ECQ-V50V-333J	1	374723334T	
C501	C-CERA C	CK725F1E-104Z1	1	332161040R1	
C502	C-CERA C	CK725F1E-104Z1	1	332161040R1	
C503	C-CERA C	CK725F1E-104Z1	1	332161040R1	

C504	UTSP C	CE04W50V-4.7M(UTSP)	1	397580477T
C505	C-CERA C	CK725F1E-104Z1	1	332161040R1
C506	C-CERA C	CK725F1E-104Z1	1	332161040R1
C507	C-CERA C	CK725F1E-104Z1	1	332161040R1
C508	C-CERA C	CC725CH1H-101J1	1	342101014R1
C509	C-CERA C	CC725CH1H-101J1	1	342101014R1
C510	C-CERA C	CC725CH1H-101J1	1	342101014R1
C511	C-CERA C	CC725CH1H-101J1	1	342101014R1
C512	C-CERA C	CK725B1H-102K1	1	332101025R1
C514	C-CERA C	CK725B1H-102K1	1	332101025R1
C515	C-CERA C	CK725F1E-104Z1	1	332161040R1
C516	C-CERA C	CK725B1H-102K1	1	332101025R1
C517	C-CERA C	CC725CH1H-101J1	1	342101014R1
C518	C-CERA C	CC725CH1H-101J1	1	342101014R1
C519	C-CERA C	CK725B1H-102K1	1	332101025R1
C520	C-CERA C	CK725B1H-102K1	1	332101025R1
C521	C-CERA C	CK725B1H-102K1	1	332101025R1
C522	C-CERA C	CK725B1H-102K1	1	332101025R1
C523	C-CERA C	CK725B1H-102K1	1	332101025R1
C524	C-CERA C	CK725B1H-102K1	1	332101025R1
C525	C-CERA C	CC725CH1H-101J1	1	342101014R1
C526	C-CERA C	CC725CH1H-101J1	1	342101014R1
C527	C-CERA C	CK725F1E-104Z1	1	332161040R1
C551	C-CERA C	CK725F1E-104Z1	1	332161040R1
C552	C-CERA C	CK725F1E-104Z1	1	332161040R1
C553	C-CERA C	CK725B1H-102K1	1	332101025R1
C554	C-CERA C	CK725B1H-102K1	1	332101025R1
C604	UTSP C	CE04W50V-4.7M(UTSP)	1	397580477T
C613	C-CERA C	CK732B1A-105K	1	337361055R2
C625	C-CERA C	CK725F1E-104Z1	1	332161040R1
C629	C-CERA C	CK725F1E-104Z1	1	332161040R1
C701	C-CERA C	CK725F1E-104Z1	1	332161040R1
C702	UTSP C	CE04W10V-100M(UTSP)	1	397531017T

C705	UTSP C	CE04W10V-100M(UTSP)	1	397531017T	
C706	UTSP C	CE04W16V-470M(UTSP)	1	397544717T	
C707	UTSP C	CE04W10V-100M(UTSP)	1	397531017T	
C708	UTSP C	CE04W10V-100M(UTSP)	1	397531017T	
C709	C-CERA C	CK725F1E-104Z1	1	332161040R1	
C744	C-CERA C	CK725F1E-104Z1	1	332161040R1	
C745	C-CERA C	CK725B0J-106K	1	332091065R2	
C747	UTSP C	CE04W50V-10M(UTSP)	1	397581007T	
C751	UTSP C	CE04W50V-0.47M(UTSP)	1	397584797T	
C753	UTSP C	CE04W16V-470M(UTSP)	1	397544717T	
C761	UTSP C	CE04W50V-0.47M(UTSP)	1	397584797T	
C762	C-CERA C	CK732B1A-105K	1	337361055R2	
C771	UTSP C	CE04W50V-0.47M(UTSP)	1	397584797T	
C772	C-CERA C	CK732B1A-105K	1	337361055R2	
C781	UTSP C	CE04W50V-0.47M(UTSP)	1	397584797T	
C782	C-CERA C	CK732B1A-105K	1	337361055R2	
C800	C-CERA C	CK725F1E-104Z1	1	332161040R1	
C801	C-CERA C	CK725B1H-103K1	1	332101035R1	
C802	C-CERA C	CK725F1E-104Z1	1	332161040R1	
C803	C-CERA C	CK725B1H-103K1	1	332101035R1	
X101	CRYSTAL	HC-49S 4.332MHz	1	3010469T	N <MPB,MPP>
X171	CRYSTAL	HC-49US24.576MHz	1	3010423T	
X171 or	CRYSTAL	HC-49/U03-24.576M	(1)	3010314T	
X171A	CUSHION	(BUTYL)	1	28141748	
X701	CERA LOCK	CSTCR5M00G53-B0	1	3010356R2	
R101	METAL O R	RS1/2WBJ-10	1	443521004T	
R107	C-CARBON R	RN72K1J-101JE	1	435031014R1	<MPB,MPP>
R108	C-CARBON R	RN72K1J-101JE	1	435031014R1	<MPB,MPP>
R110	C-CARBON R	RN72K1J-103JE	1	435031034R1	
R111	C-CARBON R	RN72K1J-105JE	1	435031054R1	
R112	METAL O R	RS1WBJ-22	1	443622204T	
R113	C-CARBON R	RN72K1J-221JE	1	435032214R1	
R114	C-CARBON R	RN72K1J-221JE	1	435032214R1	

R115	C-CARBON R	RN72K1J-333JE	1	435033334R1	
R131	C-CARBON R	RN72K1J-750JE	1	435037504R1	
R132	C-CARBON R	RN72K1J-750JE	1	435037504R1	
R133	C-CARBON R	RN72K1J-100JE	1	435031004R1	
R134	C-CARBON R	RN72K1J-100JE	1	435031004R1	
R135	C-CARBON R	RN72K1J-224JE	1	435032244R1	
R136	C-CARBON R	RN72K1J-224JE	1	435032244R1	
R137	C-CARBON R	RN72K1J-103JE	1	435031034R1	
R138	C-CARBON R	RN72K1J-103JE	1	435031034R1	
R139	C-CARBON R	RN72K1J-823JE	1	435038234R1	
R140	C-CARBON R	RN72K1J-823JE	1	435038234R1	
R141	C-CARBON R	RN72K1J-470JE	1	435034704R1	
R142	C-CARBON R	RN72K1J-470JE	1	435034704R1	
R151	C-CARBON R	RN72K1J-103JE	1	435031034R1	
R152	C-CARBON R	RN72K1J-103JE	1	435031034R1	
R153	C-CARBON R	RN72K1J-222JE	1	435032224R1	
R154	C-CARBON R	RN72K1J-103JE	1	435031034R1	
R171	C-CARBON R	RN72K1J-105JE	1	435031054R1	
R173	C-CARBON R	RN72K1J-151JE	1	435031514R1	
R181	METAL R	RNU1/2WCJ-4.7	1	453530474T	
R182	METAL R	RNU1/2WCJ-1	1	453530104T	
R2100	THERMISTOR	FUSB090F	1	4000252T	N
R2150	C-CARBON R	RN72K1J-000JE	1	435030004R1	
R2151	C-CARBON R	RN72K1J-000JE	1	435030004R1	
R2152	C-CARBON R	RN72K1J-750JE	1	435037504R1	
R301	C-CARBON R	RN72K1J-331JE	1	435033314R1	
R302	C-CARBON R	RN72K1J-331JE	1	435033314R1	
R303	C-CARBON R	RN72K1J-331JE	1	435033314R1	
R304	C-CARBON R	RN72K1J-221JE	1	435032214R1	
R305	C-CARBON R	RN72K1J-470JE	1	435034704R1	
R306	C-CARBON R	RN72K1J-221JE	1	435032214R1	
R307	C-CARBON R	RN72K1J-221JE	1	435032214R1	
R308	C-CARBON R	RN72K1J-470JE	1	435034704R1	

R309	C-CARBON R	RN72K1J-221JE	1	435032214R1
R311	C-CARBON R	RN72K1J-152JE	1	435031524R1
R312	C-CARBON R	RN72K1J-470JE	1	435034704R1
R313	C-CARBON R	RN72K1J-151JE	1	435031514R1
R314	C-CARBON R	RN72K1J-221JE	1	435032214R1
R315	C-CARBON R	RN72K1J-470JE	1	435034704R1
R316	C-CARBON R	RN72K1J-151JE	1	435031514R1
R317	C-CARBON R	RN72K1J-331JE	1	435033314R1
R318	C-CARBON R	RN72K1J-331JE	1	435033314R1
R319	C-CARBON R	RN72K1J-331JE	1	435033314R1
R320	C-CARBON R	RN72K1J-560JE	1	435035604R1
R321	C-CARBON R	RN72K1J-560JE	1	435035604R1
R323	C-CARBON R	RN72K1J-331JE	1	435033314R1
R324	C-CARBON R	RN72K1J-221JE	1	435032214R1
R325	C-CARBON R	RN72K1J-151JE	1	435031514R1
R326	C-CARBON R	RN72K1J-221JE	1	435032214R1
R330	C-CARBON R	RN72K1J-560JE	1	435035604R1
R331	C-CARBON R	RN72K1J-560JE	1	435035604R1
R333	C-CARBON R	RN72K1J-331JE	1	435033314R1
R334	C-CARBON R	RN72K1J-331JE	1	435033314R1
R336	C-CARBON R	RN72K1J-331JE	1	435033314R1
R337	C-CARBON R	RN72K1J-331JE	1	435033314R1
R339	C-CARBON R	RN72K1J-331JE	1	435033314R1
R340	C-CARBON R	RN72K1J-392JE	1	435033924R1
R341	C-CARBON R	RN72K1J-392JE	1	435033924R1
R350	C-CARBON R	RN72K1J-103JE	1	435031034R1
R351	C-CARBON R	RN72K1J-103JE	1	435031034R1
R360	C-CARBON R	RN72K1J-103JE	1	435031034R1
R361	C-CARBON R	RN72K1J-103JE	1	435031034R1
R371	C-CARBON R	RN72K1J-102JE	1	435031024R1
R400	C-CARBON R	RN72K1J-332JE	1	435033324R1
R401	C-CARBON R	RN72K1J-332JE	1	435033324R1
R402	C-CARBON R	RN72K1J-332JE	1	435033324R1

R403	C-CARBON R	RN72K1J-332JE	1	435033324R1
R404	C-CARBON R	RN72K1J-332JE	1	435033324R1
R405	C-CARBON R	RN72K1J-332JE	1	435033324R1
R406	C-CARBON R	RN72K1J-332JE	1	435033324R1
R407	C-CARBON R	RN72K1J-332JE	1	435033324R1
R408	C-CARBON R	RN72K1J-220JE	1	435032204R1
R409	C-CARBON R	RN72K1J-220JE	1	435032204R1
R410	C-CARBON R	RN72K1J-332JE	1	435033324R1
R411	C-CARBON R	RN72K1J-332JE	1	435033324R1
R412	C-CARBON R	RN72K1J-332JE	1	435033324R1
R413	C-CARBON R	RN72K1J-332JE	1	435033324R1
R414	C-CARBON R	RN72K1J-332JE	1	435033324R1
R415	C-CARBON R	RN72K1J-332JE	1	435033324R1
R416	C-CARBON R	RN72K1J-332JE	1	435033324R1
R417	C-CARBON R	RN72K1J-332JE	1	435033324R1
R420	C-CARBON R	RN72K1J-471JE	1	435034714R1
R421	C-CARBON R	RN72K1J-471JE	1	435034714R1
R422	C-CARBON R	RN72K1J-471JE	1	435034714R1
R423	C-CARBON R	RN72K1J-471JE	1	435034714R1
R424	C-CARBON R	RN72K1J-471JE	1	435034714R1
R425	C-CARBON R	RN72K1J-471JE	1	435034714R1
R426	C-CARBON R	RN72K1J-471JE	1	435034714R1
R427	C-CARBON R	RN72K1J-471JE	1	435034714R1
R430	C-CARBON R	RN72K1J-471JE	1	435034714R1
R431	C-CARBON R	RN72K1J-471JE	1	435034714R1
R432	C-CARBON R	RN72K1J-471JE	1	435034714R1
R433	C-CARBON R	RN72K1J-471JE	1	435034714R1
R434	C-CARBON R	RN72K1J-471JE	1	435034714R1
R435	C-CARBON R	RN72K1J-471JE	1	435034714R1
R436	C-CARBON R	RN72K1J-471JE	1	435034714R1
R437	C-CARBON R	RN72K1J-471JE	1	435034714R1
R440	C-CARBON R	RN72K1J-472JE	1	435034724R1
R441	C-CARBON R	RN72K1J-472JE	1	435034724R1

R442	C-CARBON R	RN72K1J-472JE	1	435034724R1
R443	C-CARBON R	RN72K1J-472JE	1	435034724R1
R444	C-CARBON R	RN72K1J-472JE	1	435034724R1
R445	C-CARBON R	RN72K1J-472JE	1	435034724R1
R446	C-CARBON R	RN72K1J-472JE	1	435034724R1
R447	C-CARBON R	RN72K1J-472JE	1	435034724R1
R450	C-CARBON R	RN72K1J-472JE	1	435034724R1
R451	C-CARBON R	RN72K1J-472JE	1	435034724R1
R452	C-CARBON R	RN72K1J-472JE	1	435034724R1
R453	C-CARBON R	RN72K1J-472JE	1	435034724R1
R454	C-CARBON R	RN72K1J-472JE	1	435034724R1
R455	C-CARBON R	RN72K1J-472JE	1	435034724R1
R456	C-CARBON R	RN72K1J-472JE	1	435034724R1
R457	C-CARBON R	RN72K1J-472JE	1	435034724R1
R460	C-CARBON R	RN72K1J-181JE	1	435031814R1
R461	C-CARBON R	RN72K1J-181JE	1	435031814R1
R462	C-CARBON R	RN72K1J-181JE	1	435031814R1
R463	C-CARBON R	RN72K1J-181JE	1	435031814R1
R464	C-CARBON R	RN72K1J-181JE	1	435031814R1
R465	C-CARBON R	RN72K1J-181JE	1	435031814R1
R466	C-CARBON R	RN72K1J-181JE	1	435031814R1
R467	C-CARBON R	RN72K1J-181JE	1	435031814R1
R470	C-CARBON R	RN72K1J-181JE	1	435031814R1
R471	C-CARBON R	RN72K1J-181JE	1	435031814R1
R472	C-CARBON R	RN72K1J-181JE	1	435031814R1
R473	C-CARBON R	RN72K1J-181JE	1	435031814R1
R474	C-CARBON R	RN72K1J-181JE	1	435031814R1
R475	C-CARBON R	RN72K1J-181JE	1	435031814R1
R476	C-CARBON R	RN72K1J-181JE	1	435031814R1
R477	C-CARBON R	RN72K1J-181JE	1	435031814R1
R500	C-CARBON R	RN72K1J-103JE	1	435031034R1
R501	C-CARBON R	RN72K1J-221JE	1	435032214R1
R502	C-CARBON R	RN72K1J-103JE	1	435031034R1

R503	C-CARBON R	RN72K1J-470JE	1	435034704R1	
R504	C-CARBON R	RN72K1J-103JE	1	435031034R1	
R505	C-CARBON R	RN72K1J-221JE	1	435032214R1	
R506	C-CARBON R	RN72K1J-221JE	1	435032214R1	<MMO,MMQ,MPA,MMR>
R507	C-CARBON R	RN72K1J-470JE	1	435034704R1	
R508	C-CARBON R	RN72K1J-470JE	1	435034704R1	
R509	C-CARBON R	RN72K1J-221JE	1	435032214R1	
R510	C-CARBON R	RN72K1J-470JE	1	435034704R1	
R511	C-CARBON R	RN72K1J-221JE	1	435032214R1	
R512	C-CARBON R	RN72K1J-273JE	1	435032734R1	
R513	C-CARBON R	RN72K1J-470JE	1	435034704R1	
R514	C-CARBON R	RN72K1J-470JE	1	435034704R1	
R515	C-CARBON R	RN72K1J-103JE	1	435031034R1	
R516	C-CARBON R	RN72K1J-272JE	1	435032724R1	
R517	C-CARBON R	RN72K1J-103JE	1	435031034R1	
R518	C-CARBON R	RN72K1J-470JE	1	435034704R1	
R519	C-CARBON R	RN72K1J-105JE	1	435031054R1	
R520	C-CARBON R	RN72K1J-103JE	1	435031034R1	
R521	C-CARBON R	RN72K1J-221JE	1	435032214R1	
R522	C-CARBON R	RN72K1J-221JE	1	435032214R1	
R523	C-CARBON R	RN72K1J-221JE	1	435032214R1	
R524	C-CARBON R	RN72K1J-221JE	1	435032214R1	
R525	C-CARBON R	RN72K1J-221JE	1	435032214R1	
R526	C-CARBON R	RN72K1J-221JE	1	435032214R1	
R527	C-CARBON R	RN72K1J-470JE	1	435034704R1	
R528	C-CARBON R	RN72K1J-470JE	1	435034704R1	
R529	C-CARBON R	RN72K1J-470JE	1	435034704R1	
R530	C-CARBON R	RN72K1J-470JE	1	435034704R1	
R531	C-CARBON R	RN72K1J-103JE	1	435031034R1	
R532	C-CARBON R	RN72K1J-221JE	1	435032214R1	
R533	C-CARBON R	RN72K1J-103JE	1	435031034R1	
R534	C-CARBON R	RN72K1J-103JE	1	435031034R1	
R535	C-CARBON R	RN72K1J-103JE	1	435031034R1	

R536	C-CARBON R	RN72K1J-103JE	1	435031034R1
R537	C-CARBON R	RN72K1J-473JE	1	435034734R1
R538	C-CARBON R	RN72K1J-103JE	1	435031034R1
R539	C-CARBON R	RN72K1J-103JE	1	435031034R1
R540	C-CARBON R	RN72K1J-470JE	1	435034704R1
R541	C-CARBON R	RN72K1J-470JE	1	435034704R1
R542	C-CARBON R	RN72K1J-470JE	1	435034704R1
R543	C-CARBON R	RN72K1J-221JE	1	435032214R1
R544	C-CARBON R	RN72K1J-470JE	1	435034704R1
R545	C-CARBON R	RN72K1J-470JE	1	435034704R1
R546	C-CARBON R	RN72K1J-470JE	1	435034704R1
R547	C-CARBON R	RN72K1J-471JE	1	435034714R1
R548	C-CARBON R	RN72K1J-102JE	1	435031024R1
R550	C-CARBON R	RN72K1J-470JE	1	435034704R1
R551	C-CARBON R	RN72K1J-470JE	1	435034704R1
R552	C-CARBON R	RN72K1J-470JE	1	435034704R1
R553	C-CARBON R	RN72K1J-470JE	1	435034704R1
R554	C-CARBON R	RN72K1J-470JE	1	435034704R1
R555	C-CARBON R	RN72K1J-470JE	1	435034704R1
R556	C-CARBON R	RN72K1J-470JE	1	435034704R1
R557	C-CARBON R	RN72K1J-470JE	1	435034704R1
R558	C-CARBON R	RN72K1J-221JE	1	435032214R1
R559	C-CARBON R	RN72K1J-103JE	1	435031034R1
R560	C-CARBON R	RN72K1J-470JE	1	435034704R1
R561	C-CARBON R	RN72K1J-470JE	1	435034704R1
R562	C-CARBON R	RN72K1J-470JE	1	435034704R1
R563	C-CARBON R	RN72K1J-221JE	1	435032214R1
R564	C-CARBON R	RN72K1J-221JE	1	435032214R1
R565	C-CARBON R	RN72K1J-221JE	1	435032214R1
R566	C-CARBON R	RN72K1J-221JE	1	435032214R1
R567	C-CARBON R	RN72K1J-470JE	1	435034704R1
R568	C-CARBON R	RN72K1J-470JE	1	435034704R1
R569	C-CARBON R	RN72K1J-470JE	1	435034704R1

R570	C-CARBON R	RN72K1J-470JE	1	435034704R1
R571	C-CARBON R	RN72K1J-470JE	1	435034704R1
R572	C-CARBON R	RN72K1J-221JE	1	435032214R1
R573	C-CARBON R	RN72K1J-221JE	1	435032214R1
R574	C-CARBON R	RN72K1J-470JE	1	435034704R1
R575	C-CARBON R	RN72K1J-103JE	1	435031034R1
R576	C-CARBON R	RN72K1J-470JE	1	435034704R1
R577	C-CARBON R	RN72K1J-103JE	1	435031034R1
R578	C-CARBON R	RN72K1J-221JE	1	435032214R1
R579	C-CARBON R	RN72K1J-221JE	1	435032214R1
R580	C-CARBON R	RN72K1J-221JE	1	435032214R1
R581	C-CARBON R	RN72K1J-221JE	1	435032214R1
R582	C-CARBON R	RN72K1J-221JE	1	435032214R1
R583	C-CARBON R	RN72K1J-473JE	1	435034734R1
R584	C-CARBON R	RN72K1J-221JE	1	435032214R1
R585	C-CARBON R	RN72K1J-273JE	1	435032734R1
R586	C-CARBON R	RN72K1J-221JE	1	435032214R1
R587	C-CARBON R	RN72K1J-102JE	1	435031024R1
R588	C-CARBON R	RN72K1J-273JE	1	435032734R1
R589	C-CARBON R	RN72K1J-102JE	1	435031024R1
R590	C-CARBON R	RN72K1J-273JE	1	435032734R1
R591	C-CARBON R	RN72K1J-102JE	1	435031024R1
R592	C-CARBON R	RN72K1J-103JE	1	435031034R1
R593	C-CARBON R	RN72K1J-102JE	1	435031024R1
R594	C-CARBON R	RN72K1J-102JE	1	435031024R1
R595	C-CARBON R	RN72K1J-470JE	1	435034704R1
R596	C-CARBON R	RN72K1J-102JE	1	435031024R1
R597	C-CARBON R	RN72K1J-103JE	1	435031034R1
R599	C-CARBON R	RN72K1J-221JE	1	435032214R1
R600	C-CARBON R	RN72K1J-470JE	1	435034704R1
R601	C-CARBON R	RN72K1J-221JE	1	435032214R1
R602	C-CARBON R	RN72K1J-221JE	1	435032214R1
R603	C-CARBON R	RN72K1J-221JE	1	435032214R1

R604	C-CARBON R	RN72K1J-221JE	1	435032214R1
R605	C-CARBON R	RN72K1J-470JE	1	435034704R1
R606	C-CARBON R	RN72K1J-222JE	1	435032224R1
R607	C-CARBON R	RN72K1J-470JE	1	435034704R1
R608	C-CARBON R	RN72K1J-222JE	1	435032224R1
R609	C-CARBON R	RN72K1J-472JE	1	435034724R1
R610	C-CARBON R	RN72K1J-472JE	1	435034724R1
R611	C-CARBON R	RN72K1J-472JE	1	435034724R1
R612	C-CARBON R	RN72K1J-272JE	1	435032724R1
R613	C-CARBON R	RN72K1J-472JE	1	435034724R1
R614	C-CARBON R	RN72K1J-272JE	1	435032724R1
R615	C-CARBON R	RN72K1J-472JE	1	435034724R1
R616	C-CARBON R	RN72K1J-272JE	1	435032724R1
R617	C-CARBON R	RN72K1J-472JE	1	435034724R1
R618	C-CARBON R	RN72K1J-272JE	1	435032724R1
R620	C-CARBON R	RN72K1J-473JE	1	435034734R1
R622	C-CARBON R	RN72K1J-470JE	1	435034704R1
R623	C-CARBON R	RN72K1J-103JE	1	435031034R1
R624	C-CARBON R	RN72K1J-470JE	1	435034704R1
R626	C-CARBON R	RN72K1J-470JE	1	435034704R1
R627	C-CARBON R	RN72K1J-470JE	1	435034704R1
R628	C-CARBON R	RN72K1J-221JE	1	435032214R1
R629	C-CARBON R	RN72K1J-470JE	1	435034704R1
R630	C-CARBON R	RN72K1J-470JE	1	435034704R1
R631	C-CARBON R	RN72K1J-470JE	1	435034704R1
R632	C-CARBON R	RN72K1J-470JE	1	435034704R1
R633	C-CARBON R	RN72K1J-470JE	1	435034704R1
R634	C-CARBON R	RN72K1J-221JE	1	435032214R1
R635	C-CARBON R	RN72K1J-103JE	1	435031034R1
R636	C-CARBON R	RN72K1J-470JE	1	435034704R1
R637	C-CARBON R	RN72K1J-103JE	1	435031034R1
R638	C-CARBON R	RN72K1J-470JE	1	435034704R1
R639	C-CARBON R	RN72K1J-470JE	1	435034704R1

R640	C-CARBON R	RN72K1J-103JE	1	435031034R1	
R641	C-CARBON R	RN72K1J-221JE	1	435032214R1	
R642	C-CARBON R	RN72K1J-470JE	1	435034704R1	
R643	C-CARBON R	RN72K1J-103JE	1	435031034R1	
R644	C-CARBON R	RN72K1J-103JE	1	435031034R1	
R645	C-CARBON R	RN72K1J-103JE	1	435031034R1	
R646	C-CARBON R	RN72K1J-470JE	1	435034704R1	
R647	C-CARBON R	RN72K1J-470JE	1	435034704R1	
R648	C-CARBON R	RN72K1J-103JE	1	435031034R1	
R649	C-CARBON R	RN72K1J-103JE	1	435031034R1	
R650	C-CARBON R	RN72K1J-103JE	1	435031034R1	
R652	C-CARBON R	RN72K1J-103JE	1	435031034R1	
R653	C-CARBON R	RN72K1J-103JE	1	435031034R1	
R654	C-CARBON R	RN72K1J-103JE	1	435031034R1	
R655	C-CARBON R	RN72K1J-221JE	1	435032214R1	
R656	C-CARBON R	RN72K1J-221JE	1	435032214R1	
R657	C-CARBON R	RN72K1J-221JE	1	435032214R1	
R658	C-CARBON R	RN72K1J-221JE	1	435032214R1	
R662	C-CARBON R	RN72K1J-000JE	1	435030004R1	
R663	C-CARBON R	RN72K1J-103JE	1	435031034R1	
R664	C-CARBON R	RN72K1J-223JE	1	435032234R1	
R665	C-CARBON R	RN72K1J-223JE	1	435032234R1	
R666	C-CARBON R	RN72K1J-223JE	1	435032234R1	
R667	C-CARBON R	RN72K1J-223JE	1	435032234R1	
R684	C-CARBON R	RN72K1J-000JE	1	435030004R1	
R685	C-CARBON R	RN72K1J-000JE	1	435030004R1	
R700	C-CARBON R	RN72K1J-103JE	1	435031034R1	<EXCEPT MDC,MDD,MDF>
R701	C-CARBON R	RN72K1J-000JE	1	435030004R1	<MDC,MDD,MDF>
R701	C-CARBON R	RN72K1J-103JE	1	435031034R1	<MPB,MPP>
R702	C-CARBON R	RN72K1J-103JE	1	435031034R1	
R705	C-CARBON R	RN72K1J-000JE	1	435030004R1	
R706	C-CARBON R	RN72K1J-103JE	1	435031034R1	<MDC,MDD,MDF>
R706	C-CARBON R	RN72K1J-333JE	1	435033334R1	<EXCEPT MDC,MDD,MDF>

R707	C-CARBON R	RN72K1J-472JE	1	435034724R1	<EXCEPT MDC,MDD,MDF>
R711	C-CARBON R	RN72K1J-470JE	1	435034704R1	
R712	C-CARBON R	RN72K1J-102JE	1	435031024R1	
R713	C-CARBON R	RN72K1J-222JE	1	435032224R1	
R714	C-CARBON R	RN72K1J-103JE	1	435031034R1	
R718	C-CARBON R	RN72K1J-221JE	1	435032214R1	
R721	C-CARBON R	RN72K1J-103JE	1	435031034R1	
R722	C-CARBON R	RN72K1J-224JE	1	435032244R1	
R723	C-CARBON R	RN72K1J-101JE	1	435031014R1	
R724	C-CARBON R	RN72K1J-101JE	1	435031014R1	
R725	C-CARBON R	RN72K1J-221JE	1	435032214R1	
R726	C-CARBON R	RN72K1J-273JE	1	435032734R1	
R761	C-CARBON R	RN72K1J-103JE	1	435031034R1	
R762	C-CARBON R	RN72K1J-222JE	1	435032224R1	
R763	C-CARBON R	RN72K1J-102JE	1	435031024R1	
R771	C-CARBON R	RN72K1J-103JE	1	435031034R1	
R772	C-CARBON R	RN72K1J-222JE	1	435032224R1	
R773	C-CARBON R	RN72K1J-102JE	1	435031024R1	
R781	C-CARBON R	RN72K1J-103JE	1	435031034R1	
R782	C-CARBON R	RN72K1J-222JE	1	435032224R1	
R783	C-CARBON R	RN72K1J-102JE	1	435031024R1	
R801	C-CARBON R	RN72K1J-000JE	1	435030004R1	
R805	C-CARBON R	RN72K1J-000JE	1	435030004R1	
R806	C-CARBON R	RN72K1J-000JE	1	435030004R1	
R807	C-CARBON R	RN72K1J-000JE	1	435030004R1	
JL5501B	WIRE TRAP	NPLG-3P586	1	25055624	
JL6610B	WIRE TRAP	NPLG-7P590	1	25055628	
JL901B	WIRE TRAP	NPLG-5P588	1	25055626	
P002	PWB	BCDG-0025	1	25140025C	N
P101A	SOCKET	NSCT-11P2104	1	25052207	
P131	PIN JACK	NPJ-2PDOO626	1	25045847	
P131 or	PIN JACK	NPJ-2PDO445	(1)	25045640	
P2001A	SOCKET	IMSA-9142S-26A	1	25053235	

P2080B	PLUG	IMSA-9142B-20A	1	25056600	
P2081	SOCKET	NNA1-01-006	1	25053357	
P5501A	SOCKET	NSCT-7P2187	1	25052290	
P5502A	SOCKET	NSCT-15P2195	1	25052298	
P5503A	SOCKET	NSCT-9P2189	1	25052292	
P5504A	SOCKET	NSCT-7P2187	1	25052290	
P701A	SOCKET	NSCT-33P2126	1	25052229	
P751A	SOCKET	IMSA-9618S-09A	1	25053334R2	N
P8001A	PLUG	IMSA-9111B-16	1	25056620	
P8002A	PLUG	IMSA-9111B-24	1	25056625	
P801	WS CLAMP	CB-71683(L=50)	1	260261	

- U003** Diplay pc board AS (BADIS-0036-1G/1H/1J)
- U0031** Switch pc board AS (BADIS-0037-1G/1H/1J)
- U0032** Video pc board AS (BAVD-0038-1G/1H/1J)
- U0033** Power supply pc board AS (BAPS-0039-1G/1H/1J)
- U0034** Headphone pc board AS (BAETC-0040-1G/1H/1J)

CIRCUIT NO.	PART NAME	DESCRIPTION	Q'TY	PART NO. (SN)	REMARKS
U7042	REMO SENS	NJL34H380A	1	241365	
D2084	ZENER D	UDZS6.8B	1	224550680R2	
D7002	ZENER D	UDZS8.2B	1	224550820R2	
D7033	ZENER D	UDZS3.9B	1	224550390R2	
D7152	LED	SLI-343URC-TE7	1	225449T	
D7154	LED	SCB3318E-D2	1	225487	N EXCEPT <MDC,MDD,MDF>
D7155	LED	SLR-342MGTE7P	1	225455T	
D7301	C-DIODE	KDS4148U	1	223283R2	
D7301 or	C-DIODE	1SS352	(1)	223234R2	
D7301 or	C-DIODE	MA2J111	(1)	223279R2	
D7302	C-DIODE	KDS4148U	1	223283R2	
D7302 or	C-DIODE	1SS352	(1)	223234R2	
D7302 or	C-DIODE	MA2J111	(1)	223279R2	
D7401	ZENER D	UDZS5.1B	1	224550510R2	

D7411	ZENER D	UDZS6.8B	1	224550680R2	
D7412	ZENER D	UDZS6.8B	1	224550680R2	
D9001	DIODE	RL1N4003	1	22380260T	
D9005	ZENER D	UDZS36B	1	224553600R2	
D9011	DIODE	D5SBA20	1	22380130F	
D9014	C-DIODE	KDS4148U	1	223283R2	
D9014 or	C-DIODE	1SS352	(1)	223234R2	
D9014 or	C-DIODE	MA2J111	(1)	223279R2	
D9015	C-DIODE	KDS4148U	1	223283R2	
D9015 or	C-DIODE	1SS352	(1)	223234R2	
D9015 or	C-DIODE	MA2J111	(1)	223279R2	
D9016	ZENER D	UDZS5.6B	1	224550560R2	<MPA,MPB,MPP>
D9016	ZENER D	UDZS6.2B	1	224550620R2	<MDC,MDD,MDF>
D9016	ZENER D	UDZS6.8B	1	224550680R2	<MMO,MMQ,MMR>
D9023	C-DIODE	KDS4148U	1	223283R2	
D9023 or	C-DIODE	1SS352	(1)	223234R2	
D9023 or	C-DIODE	MA2J111	(1)	223279R2	
D911	C-DIODE	KDS4148U	1	223283R2	
D911 or	C-DIODE	1SS352	(1)	223234R2	
D911 or	C-DIODE	MA2J111	(1)	223279R2	
D912	C-DIODE	KDS4148U	1	223283R2	
D912 or	C-DIODE	1SS352	(1)	223234R2	
D912 or	C-DIODE	MA2J111	(1)	223279R2	
D921	C-DIODE	KDS4148U	1	223283R2	
D921 or	C-DIODE	1SS352	(1)	223234R2	
D921 or	C-DIODE	MA2J111	(1)	223279R2	
D922	C-DIODE	KDS4148U	1	223283R2	
D922 or	C-DIODE	1SS352	(1)	223234R2	
D922 or	C-DIODE	MA2J111	(1)	223279R2	
D923	C-DIODE	KDS4148U	1	223283R2	
D923 or	C-DIODE	1SS352	(1)	223234R2	
D923 or	C-DIODE	MA2J111	(1)	223279R2	
D924	C-DIODE	KDS4148U	1	223283R2	

D924 or	C-DIODE	1SS352	(1)	223234R2	
D924 or	C-DIODE	MA2J111	(1)	223279R2	
D925	C-DIODE	KDS4148U	1	223283R2	
D925 or	C-DIODE	1SS352	(1)	223234R2	
D925 or	C-DIODE	MA2J111	(1)	223279R2	
D930	C-DIODE	KDS4148U	1	223283R2	
D930 or	C-DIODE	1SS352	(1)	223234R2	
D930 or	C-DIODE	MA2J111	(1)	223279R2	
D931	C-DIODE	KDS4148U	1	223283R2	
D931 or	C-DIODE	1SS352	(1)	223234R2	
D931 or	C-DIODE	MA2J111	(1)	223279R2	
D933	C-DIODE	KDS4148U	1	223283R2	
D933 or	C-DIODE	1SS352	(1)	223234R2	
D933 or	C-DIODE	MA2J111	(1)	223279R2	
D934	ZENER D	UDZS5.6B	1	224550560R2	
D935	C-DIODE	KDS4148U	1	223283R2	
D935 or	C-DIODE	1SS352	(1)	223234R2	
D935 or	C-DIODE	MA2J111	(1)	223279R2	
Q2004	IC	NJM4580M-D	1	22241448R2	
Q2072	IC	NJM2505AF	1	22242490R2	
Q3002	IC	NJW1326FH2	1	22242583R3	N
Q7002	FL TUBE	16-BT-138GNK	1	212268	
Q7002A	HOLDER	(FL)	1	27191222C	
Q7003	IC	M66005-0001AHP	1	22242208R3	
Q7004	TR	KTC3875-GR	1	2216175R2	
Q7005	TR	KRA102S	1	2216220R2	
Q7007	TR	KRC102S	1	2216190R2	
Q7033	TR	KTC3875-GR	1	2216175R2	
Q7151	TR	KTA1504-GR	1	2216185R2	EXCEPT <MDC,MDD,MDF>
Q7152	TR	KTA1504-GR	1	2216185R2	
Q7401	IC	NJM4580M-D	1	22241448R2	
Q7403	TR	DTC114TKA	1	2216670R2	
Q7404	TR	DTC114TKA	1	2216670R2	

Q9001	TR	2SC2235-Y(TPE6_F)	1	2211654T	
Q9001 or	TR	2SC2235-O(TPE6_F)	(1)	2211653T	
Q9022	IC	78M05(NJM78M05FA)	1	222780055JRC	
Q9022 or	IC	78M05AHF(MPC78M05AHF)	(1)	222780055NEC	
Q9022A	SCREW	3P+10FN(3BC)	1	82143010GR	
Q9022B	HEAT SINK	RAD-157	1	27160491	
Q9031	IC	MPC2905BHF	1	22278005DBNE	
Q9031A	SCREW	3P+10FN(3BC)	1	82143010GR	
Q9031B	HEAT SINK	RAD-140	1	27160471	
L7031	CHOKE COIL	LBC2518T2R2M	1	231364M022R2	
L7201	CHOKE COIL	LBC2518T2R2M	1	231364M022R2	
L7202	CHOKE COIL	LBC2518T2R2M	1	231364M022R2	
L7203	CHOKE COIL	LBC2518T2R2M	1	231364M022R2	
L7401	CHOKE COIL	LBC2518T2R2M	1	231364M022R2	
L7402	CHOKE COIL	LBC2518T2R2M	1	231364M022R2	
T902	P TRANS	NPT-1520JQ	1	2301812A	! <MDC,MDD,MDF>
T902	P TRANS	NPT-1520GQ	1	2301813A	! EXCEPT <MDC,MDD,MDF>
C2029	UTSP C	CE04W25V-100M(UTSP)	1	397551017T	
C2030	UTSP C	CE04W25V-100M(UTSP)	1	397551017T	
C2077	UTSP C	CE04W50V-10M(UTSP)	1	397581007T	
C2078	UTSP C	CE04W50V-10M(UTSP)	1	397581007T	
C2079	UTSP C	CE04W50V-10M(UTSP)	1	397581007T	
C2080	C-CERA C	CC725CH1H-101J1	1	342101014R1	
C2081	C-CERA C	CC725CH1H-101J1	1	342101014R1	
C2082	C-CERA C	CC725CH1H-101J1	1	342101014R1	
C2083	C-CERA C	CC725CH1H-101J1	1	342101014R1	
C2084	UTSP C	CE04W50V-10M(UTSP)	1	397581007T	
C2085	UTSP C	CE04W50V-10M(UTSP)	1	397581007T	
C2086	C-CERA C	CC725CH1H-470J1	1	342104704R1	
C2087	C-CERA C	CC725CH1H-470J1	1	342104704R1	
C2088	C-CERA C	CK725F1E-104Z1	1	332161040R1	
C2089	C-CERA C	CK725F1E-104Z1	1	332161040R1	
C2100	VR C	CE04W16V-100M(VR)	1	394641017T	

C2101	C-CERA C	CK725F1E-104Z1	1	332161040R1
C2103	VR C	CE04W6.3V-470M(VR)	1	394624717T
C2104	VR C	CE04W6.3V-470M(VR)	1	394624717T
C3001	VR C	CE04W6.3V-470M(VR)	1	394624717T
C3002	C-CERA C	CK725F1E-104Z1	1	332161040R1
C3004	VR C	CE04W6.3V-470M(VR)	1	394624717T
C3007	VR C	CE04W6.3V-470M(VR)	1	394624717T
C3011	VR C	CE04W6.3V-470M(VR)	1	394624717T
C3012	C-CERA C	CK725F1E-104Z1	1	332161040R1
C3013	VR C	CE04W6.3V-470M(VR)	1	394624717T
C3021	VR C	CE04W6.3V-470M(VR)	1	394624717T
C3024	VR C	CE04W6.3V-470M(VR)	1	394624717T
C3031	C-CERA C	CK725B1H-102K1	1	332101025R1
C3032	C-CERA C	CK725B1H-102K1	1	332101025R1
C3033	VR C	CE04W50V-10M(VR)	1	394681007T
C3036	VR C	CE04W50V-10M(VR)	1	394681007T
C3040	VR C	CE04W50V-10M(VR)	1	394681007T
C3043	C-CERA C	CK725B1H-102K1	1	332101025R1
C3044	VR C	CE04W50V-1M(VR)	1	394680107T
C3045	VR C	CE04W50V-1M(VR)	1	394680107T
C3046	VR C	CE04W50V-1M(VR)	1	394680107T
C3047	VR C	CE04W50V-1M(VR)	1	394680107T
C3048	VR C	CE04W50V-1M(VR)	1	394680107T
C3049	VR C	CE04W50V-1M(VR)	1	394680107T
C3060	VR C	CE04W50V-10M(VR)	1	394681007T
C3061	VR C	CE04W50V-10M(VR)	1	394681007T
C3085	C-CERA C	CK725F1A-105Z1	1	332181050R1
C3086	C-CERA C	CK725F1A-105Z1	1	332181050R1
C3087	C-CERA C	CK725F1A-105Z1	1	332181050R1
C3088	C-CERA C	CK725F1A-105Z1	1	332181050R1
C3091	C-CERA C	CK725F1A-105Z1	1	332181050R1
C3092	C-CERA C	CK725F1A-105Z1	1	332181050R1
C3093	C-CERA C	CK725F1A-105Z1	1	332181050R1

C3094	C-CERA C	CK725F1A-105Z1	1	332181050R1
C3095	C-CERA C	CK725F1A-105Z1	1	332181050R1
C3096	C-CERA C	CK725F1A-105Z1	1	332181050R1
C3097	C-CERA C	CK725F1A-105Z1	1	332181050R1
C3098	C-CERA C	CK725F1A-105Z1	1	332181050R1
C3099	C-CERA C	CK725F1A-105Z1	1	332181050R1
C7001	C-CERA C	CK725B1H-223K1	1	332102235R1
C7002	C-CERA C	CK725F1E-104Z1	1	332161040R1
C7003	C-CERA C	CC725CH1H-101J1	1	342101014R1
C7004	C-CERA C	CC725CH1H-101J1	1	342101014R1
C7005	C-CERA C	CC725CH1H-101J1	1	342101014R1
C7007	C-CERA C	CC725CH1H-101J1	1	342101014R1
C7008	ELECT C	CE04W6.3V-100M	1	355721019T
C7009	C-CERA C	CK725F1E-104Z1	1	332161040R1
C7010	C-CERA C	CK725B1H-223K1	1	332102235R1
C7011	C-CERA C	CK725B1H-223K1	1	332102235R1
C7012	C-CERA C	CK725B1H-223K1	1	332102235R1
C7013	ELECT C	CE04W50V-33M	1	355783309T
C7014	C-CERA C	CK725B1H-223K1	1	332102235R1
C7015	ELECT C	CE04W16V-47M(S)	1	353744709T
C7016	C-CERA C	CK725B1H-223K1	1	332102235R1
C7017	C-CERA C	CK725B1H-223K1	1	332102235R1
C7021	C-CERA C	CK725B1H-103K1	1	332101035R1
C7022	C-CERA C	CK725B1H-103K1	1	332101035R1
C7031	C-CERA C	CK725B1H-223K1	1	332102235R1
C7032	C-CERA C	CK725B1H-223K1	1	332102235R1
C7033	ELECT C	CE04W16V-10M(S)	1	353741009T
C7045	ELECT C	CE04W6.3V-100M(S)	1	353721019T
C7046	C-CERA C	CC725CH1H-102J1	1	342101024R1
C7047	C-CERA C	CC725CH1H-102J1	1	342101024R1
C7201	C-CERA C	CC725CH1H-102J1	1	342101024R1
C7202	C-CERA C	CK725B1H-223K1	1	332102235R1
C7203	MKT C	B32529C0102J289	1	376491024T

C7204	MKT C	B32529C0102J289	1	376491024T	
C7301	C-CERA C	CC725CH1H-471J1	1	342104714R1	
C7302	C-CERA C	CC725CH1H-471J1	1	342104714R1	
C7303	C-CERA C	CK725F1E-104Z1	1	332161040R1	
C7304	C-CERA C	CK725F1E-104Z1	1	332161040R1	
C7305	C-CERA C	CK725F1E-104Z1	1	332161040R1	
C7309	C-CERA C	CC725CH1H-101J1	1	342101014R1	
C7401	ELECT C	CE04W16V-10M(S)	1	353741009T	
C7402	C-CERA C	CC725CH1H-101J1	1	342101014R1	
C7403	ELECT C	CE04W16V-47M(S)	1	353744709T	
C7404	C-CERA C	CC725CH1H-330J1	1	342103304R1	
C7405	ELECT C	CE04W16V-10M(S)	1	353741009T	
C7411	ELECT C	CE04W16V-47M(S)	1	353744709T	
C7412	ELECT C	CE04W16V-47M(S)	1	353744709T	
C7421	C-CERA C	CC725CH1H-102J1	1	342101024R1	
C9001	VR C	CE04W63V-470M(VR)	1	394674717S	
C9005	VR C	CE04W50V-47M(VR)	1	394684707T	
C9006	C-CERA C	CK725F1E-104Z1	1	332161040R1	
C901	IS C	LE103-C3.5	1	3800042S	!
C901 or	IS C	ECQU2A103MLC	(1)	3800039S	!
C9011	VR C	CE04W16V-10000M(VR)	1	394641037S	
C9012	TFC	ECQ-V50V-334J	1	374723344T	
C9013	VR C	CE04W50V-2.2M(VR)	1	394680227T	
C9014	VR C	CE04W50V-1M(VR)	1	394680107T	
C902	C-CERA C	CK725F1E-104Z1	1	332161040R1	
C9023	VR C	CE04W50V-10M(VR)	1	394681007T	
C9025	VR C	CE04W6.3V-470M(VR)	1	394624717T	
C9030	VR C	CE04W25V-220M(VR)	1	394652217T	
C9031	C-CERA C	CK725F1E-104Z1	1	332161040R1	
C9032	VR C	CE04W6.3V-470M(VR)	1	394624717T	
C911	C-CERA C	CC725CH1H-102J1	1	342101024R1	
C921	C-CERA C	CK725B1H-223K1	1	332102235R1	
C922	VR C	CE04W25V-2200M(VR)	1	394652227S	

C930	UTSP C	CE04W50V-100M(UTSP)	1	397581017T	
C933	UTSP C	CE04W50V-4.7M(UTSP)	1	397580477T	
R2004	C-CARBON R	RN72K1J-000JE	1	435030004R1	
R2005	C-CARBON R	RN72K1J-000JE	1	435030004R1	
R2007	C-CARBON R	RN72K1J-000JE	1	435030004R1	
R2009	C-CARBON R	RN72K1J-000JE	1	435030004R1	
R2010	C-CARBON R	RN72K1J-000JE	1	435030004R1	
R2014	C-CARBON R	RN72K1J-000JE	1	435030004R1	
R2015	C-CARBON R	RN72K1J-000JE	1	435030004R1	
R2016	C-CARBON R	RN72K1J-000JE	1	435030004R1	
R2048	C-CARBON R	RN72K1J-220JE	1	435032204R1	
R2049	C-CARBON R	RN72K1J-220JE	1	435032204R1	
R2104	C-CARBON R	RN72K1J-223JE	1	435032234R1	
R2105	C-CARBON R	RN72K1J-223JE	1	435032234R1	
R2106	C-CARBON R	RN72K1J-223JE	1	435032234R1	
R2107	C-CARBON R	RN72K1J-223JE	1	435032234R1	
R2108	C-CARBON R	RN72K1J-223JE	1	435032234R1	
R2109	C-CARBON R	RN72K1J-223JE	1	435032234R1	
R2110	C-CARBON R	RN72K1J-223JE	1	435032234R1	
R2111	C-CARBON R	RN72K1J-223JE	1	435032234R1	
R2115	C-CARBON R	RN72K1J-471JE	1	435034714R1	EXCEPT <MMO,MMQ,MMR>
R2115	C-CARBON R	RN72K1J-681JE	1	435036814R1	<MMO,MMQ,MMR>
R2116	C-CARBON R	RN72K1J-220JE	1	435032204R1	
R2117	C-CARBON R	RN72K1J-220JE	1	435032204R1	
R2120	C-CARBON R	RN72K1J-471JE	1	435034714R1	
R2121	C-CARBON R	RN72K1J-471JE	1	435034714R1	
R2130	C-CARBON R	RN72K1J-105JE	1	435031054R1	
R2132	C-CARBON R	RN72K1J-105JE	1	435031054R1	
R3011	C-CARBON R	RN72K1J-750JE	1	435037504R1	
R3014	C-CARBON R	RN72K1J-750JE	1	435037504R1	
R3017	C-CARBON R	RN72K1J-750JE	1	435037504R1	
R3020	C-CARBON R	RN72K1J-750JE	1	435037504R1	
R3021	C-CARBON R	RN72K1J-750JE	1	435037504R1	

R3023	C-CARBON R	RN72K1J-750JE	1	435037504R1
R3026	C-CARBON R	RN72K1J-750JE	1	435037504R1
R3027	C-CARBON R	RN72K1J-750JE	1	435037504R1
R3028	C-CARBON R	RN72K1J-750JE	1	435037504R1
R3029	C-CARBON R	RN72K1J-750JE	1	435037504R1
R3030	C-CARBON R	RN72K1J-750JE	1	435037504R1
R3038	METAL R	RNU1/2WCJ-1	1	453530104T
R3041	C-CARBON R	RN72K1J-750JE	1	435037504R1
R3042	C-CARBON R	RN72K1J-750JE	1	435037504R1
R3043	C-CARBON R	RN72K1J-750JE	1	435037504R1
R3089	C-CARBON R	RN72K1J-750JE	1	435037504R1
R7001	C-CARBON R	RN72K1J-103JE	1	435031034R1
R7002	C-CARBON R	RN72K1J-332JE	1	435033324R1
R7003	C-CARBON R	RN72K1J-332JE	1	435033324R1
R7004	C-CARBON R	RN72K1J-221JE	1	435032214R1
R7005	C-CARBON R	RN72K1J-221JE	1	435032214R1
R7006	C-CARBON R	RN72K1J-103JE	1	435031034R1
R7007	C-CARBON R	RN72K1J-221JE	1	435032214R1
R7008	C-CARBON R	RN72K1J-221JE	1	435032214R1
R7021	C-CARBON R	RN72K1J-103JE	1	435031034R1
R7022	C-CARBON R	RN72K1J-103JE	1	435031034R1
R7023	C-CARBON R	RN72K1J-103JE	1	435031034R1
R7024	C-CARBON R	RN72K1J-103JE	1	435031034R1
R7033	C-CARBON R	RN72K1J-820JE	1	435038204R1
R7045	C-CARBON R	RN72K1J-101JE	1	435031014R1
R7046	C-CARBON R	RN72K1J-102JE	1	435031024R1
R7101	C-CARBON R	RN72K1J-331JE	1	435033314R1
R7102	C-CARBON R	RN72K1J-471JE	1	435034714R1
R7103	C-CARBON R	RN72K1J-561JE	1	435035614R1
R7107	C-CARBON R	RN72K1J-331JE	1	435033314R1
R7108	C-CARBON R	RN72K1J-471JE	1	435034714R1
R7109	C-CARBON R	RN72K1J-561JE	1	435035614R1
R7110	C-CARBON R	RN72K1J-821JE	1	435038214R1

R7111	C-CARBON R	RN72K1J-122JE	1	435031224R1	
R7112	C-CARBON R	RN72K1J-222JE	1	435032224R1	
R7113	C-CARBON R	RN72K1J-392JE	1	435033924R1	
R7114	C-CARBON R	RN72K1J-123JE	1	435031234R1	
R7115	C-CARBON R	RN72K1J-331JE	1	435033314R1	
R7116	C-CARBON R	RN72K1J-471JE	1	435034714R1	
R7117	C-CARBON R	RN72K1J-561JE	1	435035614R1	
R7118	C-CARBON R	RN72K1J-821JE	1	435038214R1	
R7119	C-CARBON R	RN72K1J-122JE	1	435031224R1	
R7120	C-CARBON R	RN72K1J-222JE	1	435032224R1	
R7121	C-CARBON R	RN72K1J-392JE	1	435033924R1	
R7122	C-CARBON R	RN72K1J-123JE	1	435031234R1	
R7123	C-CARBON R	RN72K1J-331JE	1	435033314R1	
R7124	C-CARBON R	RN72K1J-471JE	1	435034714R1	
R7125	C-CARBON R	RN72K1J-561JE	1	435035614R1	
R7126	C-CARBON R	RN72K1J-821JE	1	435038214R1	
R7127	C-CARBON R	RN72K1J-122JE	1	435031224R1	
R7128	C-CARBON R	RN72K1J-222JE	1	435032224R1	
R7129	C-CARBON R	RN72K1J-392JE	1	435033924R1	
R7151	C-CARBON R	RN72K1J-222JE	1	435032224R1	
R7152	C-CARBON R	RN72K1J-820JE	1	435038204R1	EXCEPT <MDC,MDD,MDF>
R7154	C-CARBON R	RN72K1J-121JE	1	435031214R1	
R7155	C-CARBON R	RN72K1J-103JE	1	435031034R1	EXCEPT <MDC,MDD,MDF>
R7156	C-CARBON R	RN72K1J-102JE	1	435031024R1	EXCEPT <MDC,MDD,MDF>
R7157	C-CARBON R	RN72K1J-103JE	1	435031034R1	
R7158	C-CARBON R	RN72K1J-102JE	1	435031024R1	
R7301	C-CARBON R	RN72K1J-331JE	1	435033314R1	
R7302	C-CARBON R	RN72K1J-331JE	1	435033314R1	
R7304	C-CARBON R	RN72K1J-000JE	1	435030004R1	
R7401	C-CARBON R	RN72K1J-101JE	1	435031014R1	
R7402	C-CARBON R	RN72K1J-224JE	1	435032244R1	
R7403	C-CARBON R	RN72K1J-472JE	1	435034724R1	
R7404	C-CARBON R	RN72K1J-221JE	1	435032214R1	

R7405	C-CARBON R	RN72K1J-473JE	1	435034734R1	
R7406	C-CARBON R	RN72K1J-331JE	1	435033314R1	
R7407	C-CARBON R	RN72K1J-102JE	1	435031024R1	
R7408	C-CARBON R	RN72K1J-333JE	1	435033334R1	
R7409	C-CARBON R	RN72K1J-221JE	1	435032214R1	
R7410	C-CARBON R	RN72K1J-221JE	1	435032214R1	
R7411	C-CARBON R	RN72K1J-471JE	1	435034714R1	
R7412	C-CARBON R	RN72K1J-471JE	1	435034714R1	
R7413	C-CARBON R	RN72K1J-224JE	1	435032244R1	
R7414	C-CARBON R	RN72K1J-104JE	1	435031044R1	
R7415	C-CARBON R	RN72K1J-000JE	1	435030004R1	
R9001	METAL O R	RS1WBJ-220	1	443622214T	
R9002	C-CARBON R	RN72K1J-822JE	1	435038224R1	
R9003	C-CARBON R	RN72K1J-822JE	1	435038224R1	
R9004	C-CARBON R	RN72K1J-333JE	1	435033334R1	
R9010	METAL O R	RS1/2WBJ-82	1	443528204T	
R9012	METAL R	RNU1/2WCJ-1	1	453530104T	
R9013	METAL R	RNU1/2WCJ-1	1	453530104T	
R9014	C-CARBON R	RN72K1J-104JE	1	435031044R1	
R9029	METAL R	RNU1WCJ-0.22	1	453632294T	
R9030	METAL O R	RS1WBJ-8.2	1	441620824F	EXCEPT <MMO,MMQ,MMR>
R9030	METAL O R	RS2WBJ-15	1	442721504F	<MMO,MMQ,MMR>
R9031	METAL R	RNU2WCJ-3.3	1	452730334F	
R9032	METAL R	RNU2WCJ-3.3	1	452730334F	
R9033	METAL R	RNU1/2WCJ-1	1	453530104T	
R9036	C-CARBON R	RN72K1J-000JE	1	435030004R1	
R921	METAL O R	RS1/2WBJ-47	1	443524704T	
R934	C-CARBON R	RN72K1J-104JE	1	435031044R1	
E7202	TRM-423(SCREW)	NEJITANSI ST3	1	25060495	
E7301A	RETAINER	(EARTH)	1	27142136A	
E9001	TRM-423(SCREW)	NEJITANSI ST3	1	25060495	
E9002	RETAINER	(JOINT)	1	27142069	
E9003	TRM-423(SCREW)	NEJITANSI ST3	1	25060495	

E901	TRM-423(SCREW)	NEJITANSI ST3	1	25060495	
E902	TRM-423(SCREW)	NEJITANSI ST3	1	25060495	
F901C	FUSE HOL	NSCT-1P2031	1	25052133T	
F901D	FUSE HOL	NSCT-1P2031	1	25052133T	
F901E	LABEL	LABEL	1	29360842	<MDC,MDD,MDF>
F901E	LABEL	T4AL250V	1	29361732A	EXCEPT <MDC,MDD,MDF>
JL5502B	WIRE TRAP	NPLG-5P588	1	25055626	
JL6605B	SOCKET	NSCT-5P97	1	25050269	
JL7101A	WIRE HOL	NSCT-9P900	1	25051113	
JL7101B	WIRE HOL	NSCT-9P900	1	25051113	
JL8001A	WIRE HOL	NSCT-5P876	1	25051089	
JL901A	WIRE HOL	NSCT-5P876	1	25051089	
JL9101B	SOCKET	NSCT-7P99	1	25050271	
P002	PWB	BCDIS-0036	1	25140036C	N
P2001B	PLUG	IMSA-9142B-26A	1	25056603	
P2080A	SOCKET	IMSA-9142S-20A	1	25053232	
P3001	PIN JACK	NPJ-3PDYYY560	1	25045778	
P3002	PIN JACK	NPJ-2PDYY679	1	25045911	
P3005	PIN JACK	NPJ-9PDGLRGLRGLR563	1	25045781	
P3005 or	PIN JACK	NPJ-9PDGLR519	(1)	25045731	
P701B	SOCKET	NSCT-33P2163	1	25052266	
P7201	ST JACK	MSJ-064-05A SR	1	25045783	
P7201 or	ST JACK	YKB21-5005	(1)	25045724	
P7301	PIN JACK	NPJ-3PDB693	1	25045925	
P7311	ST JACK	MSJ-035-05A BAG SR LF	1	25045927	
P7401	ST JACK	MSJ-035-05C B AG SR type	1	25045879	
P901A	PLUG	NPLG-2P631	1	25055675	
P901A or	PLUG	1-1123724-2	(1)	25056402	
P911	PLUG	NPLG-2P631	1	25055675	EXCEPT <MMO,MMQ,MMR>
P911 or	PLUG	1-1123724-2	(1)	25056402	EXCEPT <MMO,MMQ,MMR>
P912	PLUG	B5P9-VH	1	25056568	<MMO,MMQ,MMR>
P912 or	PLUG	1-1123724-5	(1)	25056579	<MMO,MMQ,MMR>
RL901	RELAY	NRL-1P5A-DC9-179	1	25065669	!

S7002	R ENCODE	EC12E2425WITH WASHER	1	25065655W
S7102	PUSH SW	NPS-111-S681	1	25035718T
S7104	PUSH SW	NPS-111-S681	1	25035718T
S7108	PUSH SW	NPS-111-S681	1	25035718T
S7110	PUSH SW	NPS-111-S681	1	25035718T
S7113	PUSH SW	NPS-111-S681	1	25035718T
S7115	PUSH SW	NPS-111-S681	1	25035718T
S7117	PUSH SW	NPS-111-S681	1	25035718T
S7119	PUSH SW	NPS-111-S681	1	25035718T
S7121	PUSH SW	NPS-111-S681	1	25035718T
S7125	PUSH SW	NPS-111-S681	1	25035718T
S7127	PUSH SW	NPS-111-S681	1	25035718T
S7129	PUSH SW	NPS-111-S681	1	25035718T
S7132	PUSH SW	NPS-111-S681	1	25035718T
S7134	PUSH SW	NPS-111-S681	1	25035718T
S7136	PUSH SW	NPS-111-S681	1	25035718T
S7138	PUSH SW	NPS-111-S681	1	25035718T
S7140	PUSH SW	NPS-111-S681	1	25035718T
S7142	PUSH SW	NPS-111-S681	1	25035718T
S7144	PUSH SW	NPS-111-S681	1	25035718T
S7146	PUSH SW	NPS-111-S681	1	25035718T
S7148	PUSH SW	NPS-111-S681	1	25035718T
S7150	PUSH SW	NPS-111-S681	1	25035718T
S7152	PUSH SW	NPS-111-S681	1	25035718T
S7154	PUSH SW	NPS-111-S681	1	25035718T
S7156	PUSH SW	NPS-111-S681	1	25035718T
S7158	PUSH SW	NPS-111-S681	1	25035718T
S7160	PUSH SW	NPS-111-S681	1	25035718T
S7162	PUSH SW	NPS-111-S681	1	25035718T
S7164	PUSH SW	NPS-111-S681	1	25035718T

U004 HDMI / DSP pc board AS (BAHDM-0060-1A)

CIRCUIT NO.	PART NAME	DESCRIPTION	Q'TY	PART NO. (SN)	REMARKS
D201	DIODE	RB070M-30	1	22380361R2	
D201 or	C-DIODE	CRS09(TE85L_Q)	(1)	223274R2	
D203	C-DIODE	1SR154-400	1	22380284R2	
D204	C-DIODE	KDS4148U	1	223283R2	
D204 or	C-DIODE	1SS352	(1)	223234R2	
D204 or	C-DIODE	MA2J111	(1)	223279R2	
D204 or	C-DIODE	MA2J1110GL	(1)	223302R2	
D205	C-DIODE	1SR154-400	1	22380284R2	
D8301	DIODE	DAN217T146	1	223285R2	
D8301 or	C-DIODE	1SS226(TE85L_F)	(1)	223266R2	
D8302	C-DIODE	KDS4148U	1	223283R2	
D8302 or	C-DIODE	1SS352	(1)	223234R2	
D8302 or	C-DIODE	MA2J111	(1)	223279R2	
D8302 or	C-DIODE	MA2J1110GL	(1)	223302R2	
D8591	DIODE	RB070M-30	1	22380361R2	
D8591 or	C-DIODE	CRS09(TE85L_Q)	(1)	223274R2	
D8651	C-DIODE	KDS4148U	1	223283R2	
D8651 or	C-DIODE	1SS352	(1)	223234R2	
D8651 or	C-DIODE	MA2J111	(1)	223279R2	
D8651 or	C-DIODE	MA2J1110GL	(1)	223302R2	
D8652	C-DIODE	1SR154-400	1	22380284R2	
D8653	C-DIODE	KDS4148U	1	223283R2	
D8653 or	C-DIODE	1SS352	(1)	223234R2	
D8653 or	C-DIODE	MA2J111	(1)	223279R2	
D8653 or	C-DIODE	MA2J1110GL	(1)	223302R2	
Q201	IC	D788E001BRFP266Z	1	22242502R3	
Q202	IC	TC74VHC157FT	1	22274157ER2TO	
Q203	IC	TC7WU04FU(TE12L_F)	1	22240935R2	
Q205	IC	TC74VHC157FT	1	22274157ER2TO	
Q271	IC	SI8008TM	1	22242323R2	
Q272	IC	TA48033BF(TE16L_NQ)	1	22278033DBR2TO	
Q273	IC	BD7820	1	22242300R2	

Q281	IC	K4S641632K-UC60	1	22242462R2
Q281 or	IC	K4S641632N-LC60	(1)	22242603R2
Q281 or	IC	EM638165TS-7G	(1)	22242607R2
Q282	IC (DSP program)	S29AL016D70TFI010(0313)	1	222W0063R303136
Q282 or	IC (DSP program)	ES29LV160ET-70TG(0313)	(1)	222W0069R303136
Q8305	IC	S-812C50BUC-C5ET2G	1	22242407R2
Q8306	IC	NC7SZ08P5X_F042	1	22242482R2
Q8306 or	IC	TC7SZ08FU(TE85L_F)	(1)	22242071R2TO
Q8309	IC	SN74CB3T3306DCT	1	22242454R2
Q8401	IC	SII9134CTU	1	22242394R3
Q8402	IC	TA48018BF(TE16L_NQ)	1	22278018DDBR2TO
Q8404	IC	BH18LB1WG-TR	1	22242562R2
Q8405	IC	SN74CB3Q3305PWR	1	22242258R2
Q8501	IC	SII9233ACTU	1	22242582R3
Q8593	IC	SI8008TM	1	22242323R2
Q8651	IC	BD7820	1	22242300R2
Q8652	IC	BH33FB1WG-TR	1	22242585R2
Q8653	IC	TA48033BF(TE16L_NQ)	1	22278033DDBR2TO
Q8654	IC	BD7820	1	22242300R2
L201	CHOKE COIL	BLM21PG221SN1	1	230949R2
L202	CORE	BLM18PG181SN1D	1	2350005R1
L203	C-CARBON R	RN72K1J-000JE	1	435030004R1
L204	EMIFIL	BK1608LM182-T	1	230958R1
L205	CORE	BLM18PG181SN1D	1	2350005R1
L206	EMIFIL	BK1608LM182-T	1	230958R1
L219	CORE	BLM18PG181SN1D	1	2350005R1
L241	EMIFIL	ACF451832-333-T	1	230978R2
L251	CORE	BLM18PG181SN1D	1	2350005R1
L261	EMIFIL	BK1608LM182-T	1	230958R1
L271	CHOKE COIL	NCH-2541	1	231363K470A
L271 or	COIL	0182-7310-470K-RB	(1)	231389
L272	CHOKE COIL	BLM21PG221SN1	1	230949R2
L281	CORE	BLM18PG181SN1D	1	2350005R1

L282	CORE	BLM18PG181SN1D	1	2350005R1
L283	CHOKE COIL	BLM21PG221SN1	1	230949R2
L8401	CORE	BLM18PG181SN1D	1	2350005R1
L8402	CORE	BLM18PG181SN1D	1	2350005R1
L8403	CORE	BLM18PG181SN1D	1	2350005R1
L8404	CORE	BLM18PG181SN1D	1	2350005R1
L8405	CORE	BLM18PG181SN1D	1	2350005R1
L8406	C-R NET	MNR12E0APJ000	1	43464900002R2
L8407	C-R NET	MNR12E0APJ000	1	43464900002R2
L8408	CORE	BLM18PG181SN1D	1	2350005R1
L8409	C-R NET	MNR12E0APJ000	1	43464900002R2
L8410	C-R NET	MNR12E0APJ000	1	43464900002R2
L8505	CHOKE COIL	BLM21PG221SN1	1	230949R2
L8507	CHOKE COIL	NCH-2541	1	231363K470A
L8507 or	COIL	0182-7310-470K-RB	(1)	231389
L8508	CHOKE COIL	BLM21PG221SN1	1	230949R2
L8601	CORE	BLM18PG181SN1D	1	2350005R1
L8602	CORE	BLM18PG181SN1D	1	2350005R1
L8603	CORE	BLM18PG181SN1D	1	2350005R1
L8604	CORE	BLM18PG181SN1D	1	2350005R1
L8605	CORE	BLM18PG181SN1D	1	2350005R1
L8606	CORE	BLM18PG181SN1D	1	2350005R1
L8608	EMIFIL	BK1608LM182-T	1	230958R1
L8652	CORE	BLM18PG181SN1D	1	2350005R1
X201	CRYSTAL	HC-49USSMD17.734MHz	1	3010442R2
X8501	CRYSTAL	FCX-03-27.000MMHz	1	3010473R2
C201	C-CERA C	CK725F1A-105Z1	1	332181050R1
C202	C-CERA C	CK725F1A-105Z1	1	332181050R1
C203	C-CERA C	CK725F1A-105Z1	1	332181050R1
C204	C-CERA C	CK725F1A-105Z1	1	332181050R1
C205	C-CERA C	CK725F1A-105Z1	1	332181050R1
C206	C-CERA C	CK725F1A-105Z1	1	332181050R1
C207	C-CERA C	CK725F1A-105Z1	1	332181050R1

C208	C-CERA C	CK725F1A-105Z1	1	332181050R1
C209	C-CERA C	CK725F1A-105Z1	1	332181050R1
C210	C-CERA C	CK725F1A-105Z1	1	332181050R1
C211	C-CERA C	CK725F1A-105Z1	1	332181050R1
C212	C-CERA C	CK725F1A-105Z1	1	332181050R1
C213	C-CERA C	CK725F1A-105Z1	1	332181050R1
C214	C-CERA C	CK725F1A-105Z1	1	332181050R1
C215	C-CERA C	CK725F1A-105Z1	1	332181050R1
C216	C-CERA C	CK725F1A-105Z1	1	332181050R1
C217	C-CERA C	CK725F1A-105Z1	1	332181050R1
C218	CHIP ELECT C	CEWX4V-220M	1	3981G2217R2
C219	C-CERA C	CK725F1A-105Z1	1	332181050R1
C220	C-CERA C	CK725F1A-105Z1	1	332181050R1
C221	C-CERA C	CK725F1A-105Z1	1	332181050R1
C222	C-CERA C	CK725F1A-105Z1	1	332181050R1
C223	C-CERA C	CK725F1A-105Z1	1	332181050R1
C224	C-CERA C	CK725F1A-105Z1	1	332181050R1
C225	C-CERA C	CK725F1A-105Z1	1	332181050R1
C226	C-CERA C	CK725F1A-105Z1	1	332181050R1
C227	C-CERA C	CK725F1A-105Z1	1	332181050R1
C228	C-CERA C	CK725F1A-105Z1	1	332181050R1
C229	C-CERA C	CK725F1A-105Z1	1	332181050R1
C230	C-CERA C	CK725F1A-105Z1	1	332181050R1
C231	C-CERA C	CK725F1A-105Z1	1	332181050R1
C232	C-CERA C	CK725F1A-105Z1	1	332181050R1
C233	C-CERA C	CK725F1A-105Z1	1	332181050R1
C234	C-CERA C	CK725F1A-105Z1	1	332181050R1
C235	CHIP ELECT C	CEWX4V-220M	1	3981G2217R2
C238	C-CERA C	CC725CH1H-060D1	1	342100602R1
C239	C-CERA C	CC725CH1H-060D1	1	342100602R1
C241	CHIP ELECT C	CEWX4V-220M	1	3981G2217R2
C242	C-CERA C	CK725F1E-104Z1	1	332161040R1
C243	C-CERA C	CC725CH1H-101J1	1	342101014R1

C244	C-CERA C	CK725F1A-105Z1	1	332181050R1
C245	C-CERA C	CK725F1A-105Z1	1	332181050R1
C246	C-CERA C	CK725F1A-105Z1	1	332181050R1
C247	C-CERA C	CK725F1A-105Z1	1	332181050R1
C251	C-CERA C	CK725F1A-105Z1	1	332181050R1
C252	C-CERA C	CK725F1A-105Z1	1	332181050R1
C270	CHIP ELECT C	CEWX4V-22M	1	3981G2207R2
C271	VR C	CE04W16V-470M(VR)	1	394644717T
C272	C-CERA C	CK725BIH-223K1	1	332102235R1
C273	C-CERA C	CK725F1A-105Z1	1	332181050R1
C274	CD C	UCD1A471MNL1GS	1	396634717R2
C275	C-CERA C	CK725F1A-105Z1	1	332181050R1
C276	CHIP ELECT C	CEWX4V-220M	1	3981G2217R2
C277	C-CERA C	CK725F1A-105Z1	1	332181050R1
C278	C-CERA C	CK725B0J-106K	1	332091065R2
C279	C-CERA C	CK725F1A-105Z1	1	332181050R1
C281	C-CERA C	CK725B0J-106K	1	332091065R2
C282	C-CERA C	CK725F1A-105Z1	1	332181050R1
C283	C-CERA C	CC725CH1H-102J1	1	342101024R1
C284	C-CERA C	CK725B0J-106K	1	332091065R2
C285	C-CERA C	CK725F1A-105Z1	1	332181050R1
C286	C-CERA C	CK725F1A-105Z1	1	332181050R1
C287	C-CERA C	CK725F1A-105Z1	1	332181050R1
C288	C-CERA C	CK725F1A-105Z1	1	332181050R1
C289	C-CERA C	CK725F1A-105Z1	1	332181050R1
C290	C-CERA C	CK725F1A-105Z1	1	332181050R1
C291	C-CERA C	CK725F1A-105Z1	1	332181050R1
C292	C-CERA C	CK725F1A-105Z1	1	332181050R1
C295	C-CERA C	CK725F1A-105Z1	1	332181050R1
C8198	VR C	CE04W16V-470M(VR)	1	394644717T
C8199	VR C	CE04W16V-470M(VR)	1	394644717T
C8326	C-CERA C	CK725F1A-105Z1	1	332181050R1
C8327	C-CERA C	CK725F1A-105Z1	1	332181050R1

C8328	C-CERA C	CK725B0J-106K	1	332091065R2
C8330	C-CERA C	CK725F1A-105Z1	1	332181050R1
C8331	C-CERA C	CK725F1E-104Z1	1	332161040R1
C8348	C-CERA C	CK725B1H-102K1	1	332101025R1
C8399	C-CERA C	CK725B1H-102K1	1	332101025R1
C8401	C-CERA C	CK725B0J-106K	1	332091065R2
C8402	C-CERA C	CK725B0J-106K	1	332091065R2
C8403	C-CERA C	CK725F1A-105Z1	1	332181050R1
C8404	C-CERA C	CK725B1H-102K1	1	332101025R1
C8405	C-CERA C	CK725F1A-105Z1	1	332181050R1
C8406	C-CERA C	CK725B1H-102K1	1	332101025R1
C8408	C-CERA C	CK725B0J-106K	1	332091065R2
C8409	C-CERA C	CK725B0J-106K	1	332091065R2
C8410	C-CERA C	CK725F1A-105Z1	1	332181050R1
C8411	C-CERA C	CK725B1H-102K1	1	332101025R1
C8412	C-CERA C	CK725F1A-105Z1	1	332181050R1
C8413	C-CERA C	CK725B1H-102K1	1	332101025R1
C8414	C-CERA C	CK725F1A-105Z1	1	332181050R1
C8415	C-CERA C	CK725B1H-102K1	1	332101025R1
C8416	C-CERA C	CK725B1H-102K1	1	332101025R1
C8417	C-CERA C	CK725F1A-105Z1	1	332181050R1
C8418	C-CERA C	CK725B0J-106K	1	332091065R2
C8419	C-CERA C	CK725B1H-102K1	1	332101025R1
C8420	C-CERA C	CK725F1A-105Z1	1	332181050R1
C8421	C-CERA C	CK725B1H-102K1	1	332101025R1
C8422	C-CERA C	CK725F1A-105Z1	1	332181050R1
C8423	C-CERA C	CK725B1H-102K1	1	332101025R1
C8424	C-CERA C	CK725F1A-105Z1	1	332181050R1
C8425	C-CERA C	CK725B1H-102K1	1	332101025R1
C8426	C-CERA C	CK725F1A-105Z1	1	332181050R1
C8427	C-CERA C	CK725B1H-102K1	1	332101025R1
C8428	C-CERA C	CK725F1A-105Z1	1	332181050R1
C8429	C-CERA C	CK725B1H-102K1	1	332101025R1

C8430	C-CERA C	CK725F1A-105Z1	1	332181050R1
C8431	C-CERA C	CK725B1H-102K1	1	332101025R1
C8432	C-CERA C	CK725F1A-105Z1	1	332181050R1
C8433	C-CERA C	CK725B1H-102K1	1	332101025R1
C8434	C-CERA C	CK725F1A-105Z1	1	332181050R1
C8435	C-CERA C	CK725B0J-106K	1	332091065R2
C8436	C-CERA C	CK725B0J-106K	1	332091065R2
C8437	C-CERA C	CK725B0J-106K	1	332091065R2
C8438	C-CERA C	CK725B1H-102K1	1	332101025R1
C8439	C-CERA C	CK725B0J-106K	1	332091065R2
C8441	C-CERA C	CK725F1A-105Z1	1	332181050R1
C8442	C-CERA C	CK725B0J-106K	1	332091065R2
C8443	CHIP ELECT C	CEWX4V-220M	1	3981G2217R2
C8444	C-CERA C	CK725F1A-105Z1	1	332181050R1
C8451	C-CERA C	CK725F1A-105Z1	1	332181050R1
C8452	CHIP ELECT C	CEWX4V-100M	1	3981G1017R2
C8501	C-CERA C	CK725B1H-102K1	1	332101025R1
C8502	C-CERA C	CK725B0J-106K	1	332091065R2
C8503	C-CERA C	CK725F1A-105Z1	1	332181050R1
C8504	C-CERA C	CK725B1H-102K1	1	332101025R1
C8505	C-CERA C	CK725F1A-105Z1	1	332181050R1
C8506	C-CERA C	CK725B0J-106K	1	332091065R2
C8507	C-CERA C	CK725B1H-102K1	1	332101025R1
C8508	C-CERA C	CK725F1A-105Z1	1	332181050R1
C8509	C-CERA C	CK725B1H-102K1	1	332101025R1
C8510	C-CERA C	CK725F1A-105Z1	1	332181050R1
C8511	C-CERA C	CK725B1H-102K1	1	332101025R1
C8512	C-CERA C	CK725F1A-105Z1	1	332181050R1
C8513	C-CERA C	CK725B1H-102K1	1	332101025R1
C8514	C-CERA C	CK725F1A-105Z1	1	332181050R1
C8515	C-CERA C	CK725B1H-102K1	1	332101025R1
C8516	C-CERA C	CK725F1A-105Z1	1	332181050R1
C8517	C-CERA C	CK725B1H-102K1	1	332101025R1

C8518	C-CERA C	CK725F1A-105Z1	1	332181050R1
C8519	C-CERA C	CK725F1A-105Z1	1	332181050R1
C8521	C-CERA C	CK725F1E-104Z1	1	332161040R1
C8522	C-CERA C	CK725B0J-106K	1	332091065R2
C8523	C-CERA C	CK725F1A-105Z1	1	332181050R1
C8524	C-CERA C	CK725B0J-106K	1	332091065R2
C8525	C-CERA C	CK725B0J-106K	1	332091065R2
C8527	C-CERA C	CK725B1H-102K1	1	332101025R1
C8530	C-CERA C	CK725F1A-105Z1	1	332181050R1
C8531	C-CERA C	CK725B1H-102K1	1	332101025R1
C8532	C-CERA C	CK725F1A-105Z1	1	332181050R1
C8533	C-CERA C	CK725B1H-102K1	1	332101025R1
C8534	C-CERA C	CK725F1A-105Z1	1	332181050R1
C8535	C-CERA C	CK725B1H-102K1	1	332101025R1
C8536	C-CERA C	CK725F1A-105Z1	1	332181050R1
C8537	C-CERA C	CK725B1H-102K1	1	332101025R1
C8538	C-CERA C	CK725F1A-105Z1	1	332181050R1
C8539	C-CERA C	CK725B1H-102K1	1	332101025R1
C8548	C-CERA C	CK725F1A-105Z1	1	332181050R1
C8549	C-CERA C	CK725B1H-102K1	1	332101025R1
C8550	C-CERA C	CK725F1A-105Z1	1	332181050R1
C8551	C-CERA C	CK725B1H-102K1	1	332101025R1
C8552	C-CERA C	CK725F1A-105Z1	1	332181050R1
C8553	C-CERA C	CK725B1H-102K1	1	332101025R1
C8554	C-CERA C	CK725F1A-105Z1	1	332181050R1
C8555	C-CERA C	CK725B1H-102K1	1	332101025R1
C8556	C-CERA C	CK725F1A-105Z1	1	332181050R1
C8557	C-CERA C	CK725B1H-102K1	1	332101025R1
C8558	C-CERA C	CK725F1A-105Z1	1	332181050R1
C8559	C-CERA C	CK725B1H-102K1	1	332101025R1
C8560	C-CERA C	CK725B0J-106K	1	332091065R2
C8563	C-CERA C	CK725F1A-105Z1	1	332181050R1
C8564	C-CERA C	CK725B0J-106K	1	332091065R2

C8565	C-CERA C	CK725B0J-106K	1	332091065R2
C8566	C-CERA C	CK725B1H-102K1	1	332101025R1
C8567	C-CERA C	CK725F1A-105Z1	1	332181050R1
C8573	C-CERA C	CK725F1A-105Z1	1	332181050R1
C8574	C-CERA C	CC725CH1H-100D1	1	342101002R1
C8575	C-CERA C	CC725CH1H-100D1	1	342101002R1
C8581	C-CERA C	CK725F1E-104Z1	1	332161040R1
C8582	CHIP ELECT C	CEWX4V-100M	1	3981G1017R2
C8583	C-CERA C	CK725F1A-105Z1	1	332181050R1
C8584	C-CERA C	CK725B0J-106K	1	332091065R2
C8585	C-CERA C	CK725B0J-106K	1	332091065R2
C8605	C-CERA C	CK725B1H-102K1	1	332101025R1
C8606	C-CERA C	CK725B1H-102K1	1	332101025R1
C8608	C-CERA C	CK725F1A-105Z1	1	332181050R1
C8609	C-CERA C	CK725B0J-106K	1	332091065R2
C8611	C-CERA C	CK725B1H-102K1	1	332101025R1
C8612	C-CERA C	CK725B1H-102K1	1	332101025R1
C8621	C-CERA C	CK725B1H-102K1	1	332101025R1
C8622	C-CERA C	CK725B1H-102K1	1	332101025R1
C8631	C-CARBON R	RN72K1J-000JE	1	435030004R1
C8632	C-CERA C	CK725B1H-102K1	1	332101025R1
C8680	CD C	UCD1A471MNL1GS	1	396634717R2
C8681	C-CERA C	CK725F1A-105Z1	1	332181050R1
C8682	C-CERA C	CK725B1H-223K1	1	332102235R1
C8683	VR C	CE04W16V-470M(VR)	1	394644717T
C8684	C-CERA C	CK725F1A-105Z1	1	332181050R1
C8685	C-CERA C	CK725F1E-104Z1	1	332161040R1
C8687	C-CERA C	CK725F1E-104Z1	1	332161040R1
C8688	C-CERA C	CK725F1E-104Z1	1	332161040R1
C8689	C-CERA C	CK725F1E-104Z1	1	332161040R1
C8690	C-CERA C	CK725F1E-104Z1	1	332161040R1
R200	C-CARBON R	RN72K1J-221JE	1	435032214R1
R201	C-CARBON R	RN72K1J-103JE	1	435031034R1

R202	C-CARBON R	RN72K1J-103JE	1	435031034R1
R203	C-CARBON R	RN72K1J-103JE	1	435031034R1
R205	C-CARBON R	RN72K1J-103JE	1	435031034R1
R206	C-CARBON R	RN72K1J-221JE	1	435032214R1
R207	C-CARBON R	RN72K1J-221JE	1	435032214R1
R208	C-CARBON R	RN72K1J-103JE	1	435031034R1
R209	C-CARBON R	RN72K1J-470JE	1	435034704R1
R210	C-R NET	RM7LJ330X04	1	43484733004R2
R211	C-R NET	RM7LJ330X04	1	43484733004R2
R212	C-R NET	RM7LJ330X04	1	43484733004R2
R213	C-R NET	RM7LJ330X04	1	43484733004R2
R214	C-R NET	RM7LJ330X04	1	43484733004R2
R215	C-R NET	RM7LJ330X04	1	43484733004R2
R216	C-R NET	RM7LJ330X04	1	43484733004R2
R217	C-R NET	RM7LJ330X04	1	43484733004R2
R218	C-R NET	RM7LJ330X04	1	43484733004R2
R221	C-CARBON R	RN72K1J-750JE	1	435037504R1
R230	C-CARBON R	RN72K1J-331JE	1	435033314R1
R231	C-CARBON R	RN72K1J-331JE	1	435033314R1
R232	C-CARBON R	RN72K1J-331JE	1	435033314R1
R233	C-CARBON R	RN72K1J-470JE	1	435034704R1
R234	C-CARBON R	RN72K1J-331JE	1	435033314R1
R235	C-CARBON R	RN72K1J-331JE	1	435033314R1
R236	C-CARBON R	RN72K1J-470JE	1	435034704R1
R237	C-CARBON R	RN72K1J-331JE	1	435033314R1
R238	C-CARBON R	RN72K1J-221JE	1	435032214R1
R239	C-CARBON R	RN72K1J-470JE	1	435034704R1
R240	C-CARBON R	RN72K1J-331JE	1	435033314R1
R241	C-CARBON R	RN72K1J-331JE	1	435033314R1
R242	C-CARBON R	RN72K1J-470JE	1	435034704R1
R243	C-CARBON R	RN72K1J-221JE	1	435032214R1
R244	C-CARBON R	RN72K1J-470JE	1	435034704R1
R245	C-CARBON R	RN72K1J-103JE	1	435031034R1

R246	C-CARBON R	RN72K1J-000JE	1	435030004R1
R250	C-CARBON R	RN72K1J-472JE	1	435034724R1
R251	C-CARBON R	RN72K1J-221JE	1	435032214R1
R252	C-CARBON R	RN72K1J-331JE	1	435033314R1
R253	C-CARBON R	RN72K1J-470JE	1	435034704R1
R254	C-CARBON R	RN72K1J-470JE	1	435034704R1
R255	C-CARBON R	RN72K1J-470JE	1	435034704R1
R256	C-CARBON R	RN72K1J-470JE	1	435034704R1
R257	C-CARBON R	RN72K1J-470JE	1	435034704R1
R258	C-CARBON R	RN72K1J-470JE	1	435034704R1
R259	C-CARBON R	RN72K1J-331JE	1	435033314R1
R260	C-CARBON R	RN72K1J-470JE	1	435034704R1
R261	C-CARBON R	RN72K1J-470JE	1	435034704R1
R262	C-CARBON R	RN72K1J-331JE	1	435033314R1
R263	C-CARBON R	RN72K1J-331JE	1	435033314R1
R264	C-CARBON R	RN72K1J-331JE	1	435033314R1
R265	C-CARBON R	RN72K1J-470JE	1	435034704R1
R266	C-CARBON R	RN72K1J-221JE	1	435032214R1
R267	C-CARBON R	RN72K1J-105JE	1	435031054R1
R268	C-CARBON R	RN72K1J-331JE	1	435033314R1
R269	C-CARBON R	RN72K1J-331JE	1	435033314R1
R270	C-CARBON R	RN72K1J-331JE	1	435033314R1
R271	C-CARBON R	RN72K1J-470JE	1	435034704R1
R272	C-CARBON R	RN72K1J-331JE	1	435033314R1
R273	C-CARBON R	RN72K1J-331JE	1	435033314R1
R274	C-CARBON R	RN72K1J-470JE	1	435034704R1
R275	C-CARBON R	RN72K1J-221JE	1	435032214R1
R276	C-CARBON R	RN72K1J-221JE	1	435032214R1
R277	C-CARBON R	RN72K1J-151JE	1	435031514R1
R278	C-CARBON R	RN72K1J-331JE	1	435033314R1
R279	C-CARBON R	RN72K1J-331JE	1	435033314R1
R280	C-CARBON R	RN72K1J-470JE	1	435034704R1
R281	C-CARBON R	RN72K1J-103JE	1	435031034R1

R282	C-CARBON R	RN72K1J-103JE	1	435031034R1
R283	C-CARBON R	RN72K1J-103JE	1	435031034R1
R284	C-CARBON R	RN72K1J-103JE	1	435031034R1
R285	C-CARBON R	RN72K1J-103JE	1	435031034R1
R286	C-CARBON R	RN72K1J-331JE	1	435033314R1
R287	C-CARBON R	RN72K1J-103JE	1	435031034R1
R288	C-CARBON R	RN72K1J-103JE	1	435031034R1
R289	C-CARBON R	RN72K1J-472JE	1	435034724R1
R290	C-CARBON R	RN72K1J-472JE	1	435034724R1
R291	C-CARBON R	RN72K1J-332JE	1	435033324R1
R292	C-CARBON R	RN72K1J-333JE	1	435033334R1
R293	C-CARBON R	RN72K1J-152JE	1	435031524R1
R294	C-CARBON R	RN72K1J-152JE	1	435031524R1
R295	C-CARBON R	RN72K1J-333JE	1	435033334R1
R296	C-CARBON R	RN72K1J-224JE	1	435032244R1
R297	C-CARBON R	RN72K1J-223JE	1	435032234R1
R8332	C-CARBON R	RN72K1J-102JE	1	435031024R1
R8333	C-CARBON R	RN72K1J-103JE	1	435031034R1
R8334	C-CARBON R	RN72K1J-182JE	1	435031824R1
R8335	C-CARBON R	RN72K1J-182JE	1	435031824R1
R8336	C-CARBON R	RN72K1J-472JE	1	435034724R1
R8337	C-CARBON R	RN72K1J-473JE	1	435034734R1
R8338	C-CARBON R	RN72K1J-473JE	1	435034734R1
R8339	C-CARBON R	RN72K2E-470JE	1	435224704R1
R8401	C-R NET	RM7LJ220X04	1	43484722004R2
R8402	C-CARBON R	RN72K1J-221JE	1	435032214R1
R8403	C-R NET	RM7LJ220X04	1	43484722004R2
R8404	C-CARBON R	RN72K1J-220JE	1	435032204R1
R8405	C-CARBON R	RN72K1J-220JE	1	435032204R1
R8408	C-CARBON R	RN72K1J-220JE	1	435032204R1
R8409	C-CARBON R	RN72K1J-101JE	1	435031014R1
R8410	C-CARBON R	RN72K1J-681JE	1	435036814R1
R8411	C-CARBON R	RN72K1J-472JE	1	435034724R1

R8414	C-CARBON R	RN72K1J-472JE	1	435034724R1
R8415	C-CARBON R	RN72K1J-472JE	1	435034724R1
R8416	C-R NET	RM7LJ220X04	1	43484722004R2
R8417	C-R NET	RM7LJ220X04	1	43484722004R2
R8418	C-R NET	RM7LJ220X04	1	43484722004R2
R8419	C-R NET	RM7LJ220X04	1	43484722004R2
R8420	C-R NET	RM7LJ220X04	1	43484722004R2
R8421	C-R NET	RM7LJ220X04	1	43484722004R2
R8422	C-R NET	RM7LJ220X04	1	43484722004R2
R8423	C-R NET	RM7LJ220X04	1	43484722004R2
R8424	C-R NET	RM7LJ220X04	1	43484722004R2
R8425	C-CARBON R	RN72K1J-220JE	1	435032204R1
R8426	C-CARBON R	RN72K1J-473JE	1	435034734R1
R8427	C-CARBON R	RN72K1J-473JE	1	435034734R1
R8429	C-CARBON R	RN72K1J-220JE	1	435032204R1
R8431	C-CARBON R	RN72K1J-472JE	1	435034724R1
R8432	C-CARBON R	RN72K1J-220JE	1	435032204R1
R8442	C-CARBON R	RN72K1J-102JE	1	435031024R1
R8501	C-CARBON R	RN72K1J-330JE	1	435033304R1
R8502	C-CARBON R	RN72K1J-330JE	1	435033304R1
R8503	C-CARBON R	RN72K1J-330JE	1	435033304R1
R8504	C-R NET	RM7LJ330X04	1	43484733004R2
R8505	C-R NET	RM7LJ330X04	1	43484733004R2
R8506	C-CARBON R	RN72K1J-120JE	1	435031204R1
R8507	C-R NET	RM7LJ330X04	1	43484733004R2
R8508	C-R NET	RM7LJ330X04	1	43484733004R2
R8509	C-R NET	RM7LJ330X04	1	43484733004R2
R8510	C-R NET	RM7LJ330X04	1	43484733004R2
R8511	C-R NET	RM7LJ330X04	1	43484733004R2
R8512	C-R NET	RM7LJ330X04	1	43484733004R2
R8513	C-R NET	RM7LJ330X04	1	43484733004R2
R8514	C-CARBON R	RN72K1J-472JE	1	435034724R1
R8515	C-CARBON R	RN72K1J-472JE	1	435034724R1

R8516	C-CARBON R	RN72K1J-101JE	1	435031014R1
R8517	C-CARBON R	RN72K1J-101JE	1	435031014R1
R8518	C-CARBON R	RN72K1J-472JE	1	435034724R1
R8519	C-CARBON R	RN72K1J-151JE	1	435031514R1
R8520	C-CARBON R	RN72K1J-330JE	1	435033304R1
R8521	C-CARBON R	RN72K1J-330JE	1	435033304R1
R8522	C-R NET	RM7LJ330X04	1	43484733004R2
R8523	C-CARBON R	RN72K1J-330JE	1	435033304R1
R8524	C-CARBON R	RN72K1J-330JE	1	435033304R1
R8525	C-CARBON R	RN72K1J-472JE	1	435034724R1
R8526	C-CARBON R	RN72K1J-472JE	1	435034724R1
R8529	C-CARBON R	RN72K1J-102JE	1	435031024R1
R8530	C-CARBON R	RN72K1J-105JE	1	435031054R1
R8532	C-CARBON R	RN72K1J-000JE	1	435030004R1
R8591	C-CARBON R	RN72K1J-332JE	1	435033324R1
R8592	C-CARBON R	RN72K1J-333JE	1	435033334R1
R8593	C-CARBON R	RN72K1J-152JE	1	435031524R1
R8594	C-CARBON R	RN72K1J-152JE	1	435031524R1
R8595	C-CARBON R	RN72K1J-000JE	1	435030004R1
R8597	C-CARBON R	RN72K1J-101JE	1	435031014R1
R8602	C-CARBON R	RN72K1J-000JE	1	435030004R1
R8607	C-CARBON R	RN72K1J-473JE	1	435034734R1
R8608	C-CARBON R	RN72K1J-473JE	1	435034734R1
R8609	C-CARBON R	RN72K1J-000JE	1	435030004R1
R8612	C-CARBON R	RN72K1J-000JE	1	435030004R1
R8617	C-CARBON R	RN72K1J-473JE	1	435034734R1
R8618	C-CARBON R	RN72K1J-473JE	1	435034734R1
R8619	C-CARBON R	RN72K1J-000JE	1	435030004R1
R8622	C-CARBON R	RN72K1J-000JE	1	435030004R1
R8627	C-CARBON R	RN72K1J-473JE	1	435034734R1
R8628	C-CARBON R	RN72K1J-473JE	1	435034734R1
R8629	C-CARBON R	RN72K1J-000JE	1	435030004R1
R8632	C-CARBON R	RN72K1J-000JE	1	435030004R1

R8637	C-CARBON R	RN72K1J-473JE	1	435034734R1	
R8638	C-CARBON R	RN72K1J-473JE	1	435034734R1	
R8639	C-CARBON R	RN72K1J-000JE	1	435030004R1	
R8651	C-CARBON R	RN72K1J-223JE	1	435032234R1	
R8652	C-CARBON R	RN72K1J-224JE	1	435032244R1	
R8653	C-CARBON R	RN72K1J-333JE	1	435033334R1	
R8654	C-CARBON R	RN72K1J-223JE	1	435032234R1	
R8655	C-CARBON R	RN72K1J-224JE	1	435032244R1	
R8656	C-CARBON R	RN72K1J-333JE	1	435033334R1	
JL8001B	WIRE TRAP	NPLG-5P588	1	25055626	
P004	PWB	BCHDM-0060	1	25140060B	N
P8001B	SOCKET	IMSA-9111S-16L	1	25053258	
P8002B	SOCKET	IMSA-9111S-24L	1	25053259	
P8302	SOCKET	YKF45-7037V	1	25053253R3	
P8601	SOCKET	YKF45-7037V	1	25053253R3	
P8611	SOCKET	YKF45-7037V	1	25053253R3	
P8621	SOCKET	YKF45-7037V	1	25053253R3	
P8631	SOCKET	YKF45-7037V	1	25053253R3	

U005 SP terminal pc board AS (BATRM-0029-1A/1B)

CIRCUIT NO.	PART NAME	DESCRIPTION	Q'TY	PART NO. (SN)	REMARKS
D6600	DIODE	ISS133	1	223163T	
D6603	DIODE	ISS133	1	223163T	
D6607	DIODE	ISS133	1	223163T	
Q6601	TR	KRC105M	1	2215830T	
Q6601 or	TR	RN1205	(1)	2214660T	
Q6602	TR	KRC105M	1	2215830T	
Q6602 or	TR	RN1205	(1)	2214660T	
Q6604	TR	KRC105M	1	2215830T	
Q6604 or	TR	RN1205	(1)	2214660T	
L6600	S COIL	S-1.3C	1	231176S	<MMO,MMQ,MPA,MPB,MPP,MMR>
L6600 or	S COIL	SC-0.8X11.5X12.5T-6.5L	(1)	231393S	N <MMO,MMQ,MPA,MPB,MPP,MMR>

L6601	S COIL	S-1.3C	1	231176S	<MMO,MMQ,MPA,MPB,MPP,MMR>
L6601 or	S COIL	SC-0.8X11.5X12.5T-6.5L	(1)	231393S	N <MMO,MMQ,MPA,MPB,MPP,MMR>
L6602	S COIL	S-1.3C	1	231176S	<MMO,MMQ,MPA,MPB,MPP,MMR>
L6602 or	S COIL	SC-0.8X11.5X12.5T-6.5L	(1)	231393S	N <MMO,MMQ,MPA,MPB,MPP,MMR>
L6603	S COIL	S-1.3C	1	231176S	<MMO,MMQ,MPA,MPB,MPP,MMR>
L6603 or	S COIL	SC-0.8X11.5X12.5T-6.5L	(1)	231393S	N <MMO,MMQ,MPA,MPB,MPP,MMR>
L6604	S COIL	S-1.3C	1	231176S	<MMO,MMQ,MPA,MPB,MPP,MMR>
L6604 or	S COIL	SC-0.8X11.5X12.5T-6.5L	(1)	231393S	N <MMO,MMQ,MPA,MPB,MPP,MMR>
L6605	S COIL	S-1.3C	1	231176S	<MMO,MMQ,MPA,MPB,MPP,MMR>
L6605 or	S COIL	SC-0.8X11.5X12.5T-6.5L	(1)	231393S	N <MMO,MMQ,MPA,MPB,MPP,MMR>
L6606	S COIL	S-1.3C	1	231176S	<MMO,MMQ,MPA,MPB,MPP,MMR>
L6606 or	S COIL	SC-0.8X11.5X12.5T-6.5L	(1)	231393S	N <MMO,MMQ,MPA,MPB,MPP,MMR>
C6600	TF C	ECQ-V50V-103J	1	374721034T	
C6602	TF C	ECQ-V50V-103J	1	374721034T	
C6603	TF C	ECQ-V50V-103J	1	374721034T	
C6607	TF C	ECQ-V50V-103J	1	374721034T	
C6640	TF C	ECQ-V50V-103J	1	374721034T	<MMO,MMQ,MPA,MPB,MPP,MMR>
C6641	TF C	ECQ-V50V-103J	1	374721034T	<MMO,MMQ,MPA,MPB,MPP,MMR>
C6642	TF C	ECQ-V50V-103J	1	374721034T	<MMO,MMQ,MPA,MPB,MPP,MMR>
C6643	TF C	ECQ-V50V-103J	1	374721034T	<MMO,MMQ,MPA,MPB,MPP,MMR>
C6644	TF C	ECQ-V50V-103J	1	374721034T	<MMO,MMQ,MPA,MPB,MPP,MMR>
C6650	MKT C	B32529C0102J289	1	376491024T	<MMO,MMQ,MPA,MPB,MPP,MMR>
C6651	MKT C	B32529C0102J289	1	376491024T	<MMO,MMQ,MPA,MPB,MPP,MMR>
C6652	MKT C	B32529C0102J289	1	376491024T	<MMO,MMQ,MPA,MPB,MPP,MMR>
C6653	MKT C	B32529C0102J289	1	376491024T	<MMO,MMQ,MPA,MPB,MPP,MMR>
C6654	MKT C	B32529C0102J289	1	376491024T	<MMO,MMQ,MPA,MPB,MPP,MMR>
R6600	CARBON R	R16J-22	1	417342204T	<MMO,MMQ,MPA,MPB,MPP,MMR>
R6601	CARBON R	R16J-22	1	417342204T	<MMO,MMQ,MPA,MPB,MPP,MMR>
R6602	CARBON R	R16J-22	1	417342204T	<MMO,MMQ,MPA,MPB,MPP,MMR>
R6603	CARBON R	R16J-22	1	417342204T	<MMO,MMQ,MPA,MPB,MPP,MMR>
R6604	CARBON R	R16J-22	1	417342204T	<MMO,MMQ,MPA,MPB,MPP,MMR>
R6605	CARBON R	R16J-22	1	417342204T	<MMO,MMQ,MPA,MPB,MPP,MMR>
R6606	CARBON R	R16J-22	1	417342204T	<MMO,MMQ,MPA,MPB,MPP,MMR>

R6610	CARBON R	R16J-22	1	417342204T	<MMO,MMQ,MPA,MPB,MPP,MMR>
R6611	CARBON R	R16J-22	1	417342204T	<MMO,MMQ,MPA,MPB,MPP,MMR>
R6612	CARBON R	R16J-22	1	417342204T	<MMO,MMQ,MPA,MPB,MPP,MMR>
R6613	CARBON R	R16J-22	1	417342204T	<MMO,MMQ,MPA,MPB,MPP,MMR>
R6614	CARBON R	R16J-22	1	417342204T	<MMO,MMQ,MPA,MPB,MPP,MMR>
R6615	CARBON R	R16J-22	1	417342204T	<MMO,MMQ,MPA,MPB,MPP,MMR>
R6616	CARBON R	R16J-22	1	417342204T	<MMO,MMQ,MPA,MPB,MPP,MMR>
R6690	METAL O R	RS1/2WBJ-10	1	443521004T	
R6691	METAL O R	RS1/2WBJ-390	1	443523914T	
R6692	METAL O R	RS1/2WBJ-390	1	443523914T	
JL6600B	SOCKET	NSCT-7P99	1	25050271	
JL6603B	SOCKET	NSCT-9P101	1	25050273	
JL6604B	SOCKET	NSCT-5P97	1	25050269	
JL6605A	WIRE HOL	NSCT-5P896	1	25051109	
JL6610A	WIRE HOL	NSCT-7P878	1	25051091	
P003	PWB	BCTRM-0029	1	25140029B	N
P6601	TRM	NTM-2PDMCR400	1	25060472	
P6602	TRM	NTM-4PDMNRR420	1	25060492	
P6603	TRM	NTM-4PDMNRR420	1	25060492	
RL6600	RELAY	NRL-2P5A-DC24-129	1	25065563A	
RL6600 or	RELAY	NRL-2P5A-DC24-193	(1)	25065703	
RL6602	RELAY	NRL-2P5A-DC24-129	1	25065563A	
RL6602 or	RELAY	NRL-2P5A-DC24-193	(1)	25065703	
RL6603	RELAY	NRL-2P5A-DC24-129	1	25065563A	
RL6603 or	RELAY	NRL-2P5A-DC24-193	(1)	25065703	
RL6607	RELAY	NRL-2P5A-DC24-129	1	25065563A	
RL6607 or	RELAY	NRL-2P5A-DC24-193	(1)	25065703	

TX-SR507

PACKING PROCEDURES PARTS LIST

REF. NO.	PART NAME	DESCRIPTION	Q'TY	PART NO. (SN)	REMARKS
[PACKING]					

A601	PAD	(AS)307	1	29092452A	
A605	POLY BAG	w850xd650	1	29100245	
A606	TAPE	(SEROHAN)NITTO NO.29	1	29110149	
A608	SHEET	---	1	29095906	<EXCEPT MO, MQ, MR>
A608	SHEET	T0.5x600x500	1	29096097	<MO, MQ, MR>
A610	TAPE	(SEROHAN)NITTO NO.29	1	29110149	
A612	SHEET	(PAD)	1	29096095	<PP>
A701	CARTON	507DD	1	29055036	N <DC, DD, DF>
A701	CARTON	--507	1	29054994A	N <EXCEPT DC, DD, DF>
A704A	UPC LABEL	507BDD	{ 1 }	29390701	N <BDD>
A704A	UPC LABEL	507SDD	{ 1 }	29390702	N <SDD>
A704A	UPC LABEL	507BDC	{ 1 }	29390703	N <BDC>
A704A	EAN LABEL	507BPB	{ 1 }	29390716	N <BPB>
A704A	EAN LABEL	507SPB	{ 1 }	29390717	N <SPB>
A704A	EAN LABEL	507BDF	{ 1 }	29390718	N <BDF>
A704A	EAN LABEL	507GMR	{ 1 }	29390721	N <GMR>
A704A	EAN LABEL	507BMQ	{ 1 }	29390724	N <BMQ>
A704A	EAN LABEL	507GDF	{ 1 }	29390754	N <GDF>
A704A	EAN LABEL	507BPP	{ 1 }	29390714A	N <BPP>
A704A	EAN LABEL	507SPP	{ 1 }	29390715A	N <SPP>
A704A	EAN LABEL	507BMO	{ 1 }	29390719A	N <BMO>
A704A	EAN LABEL	507SMO	{ 1 }	29390720A	N <SMO>
A704A	EAN LABEL	507BPA	{ 1 }	29390722A	N <BPA>
A704A	EAN LABEL	507SPA	{ 1 }	29390723A	N <SPA>
A707	LABEL	(CHINA)	1	29390370	<GMR>
A751	LABEL	(TWN)TX-SR507(B)	2	29390764	N <BDF>
A751	LABEL	(TWN)TX-SR507(G)	2	29390765	N <GDF>
A755	LABEL	(CCC)	1	29364396	<GMR>
A760	PP TAPE	W50 SBT-70	1	29110200	
[ACCESSARY]					
A672	POLY BAG	w250xd350	1	29100250A	<MO, MQ, PA, PB, PP>
A673	POLY BAG	---	1	29100225A	<MO>
A674	POLY BAG	D250xd300xW300(t0.04)	1	29100256A	

A676	TAPE	(SEROHAN)NITTO NO.29	1	29110149	
A801	INS MANUAL	En(TX-SR507)	1	29344940B	N
A802	INS MANUAL	U2FrEs(TX-SR507)	1	29344941B	N <DC, PP>
A803	INS MANUAL	U2ItDe(TX-SR507)	1	29344942B	N <PP>
A804	INS MANUAL	U2NISv(TX-SR507)	1	29344943B	N <PP>
A805	INS MANUAL	Ct(TX-SR507)	1	29344944A	N <DF, MO, MQ>
A806	INS MANUAL	Cs(TX-SR507)	1	29344945A	N <MR>
A807	INS MANUAL	Ar(TX-SR507)	1	29344946	N <MO>
A809	INS MANUAL	(QC ImportantSheet)	1	29344267A	<MO>
A811	INS MANUAL	U9(RC736/737/738/739)	1	29344962	
A816	INS MANUAL	En(QSS TX-SR507)	1	29344948	N
A817	INS MANUAL	Cs(QSS TX-SR507)	1	29344949	N <MR>
A820	INST SHEET	WEEE	1	29355537A	<PB, PP>
A821	INST SHEET	En(2009E_RIHD)	1	29355745	
A822	INST SHEET	U2FrEs(2009E_RIHD)	1	29355746	<DC>
A823	INST SHEET	U8(2009E_RIHD)	1	29355747	<DF, MO, MQ, PP, MR>
A825	INST SHEET	Ct(CHUISI_MDF)	1	29355749	<DF>
A835	HANDBILL	(UP-A1)US	1	29380155	<DC, DD>
A835	HANDBILL	(UP-A1)EU	1	29380156	<PB, PP>
A855	REMO CON	RC-737M	1	24140737	N
A856	MIC	MIC-7000	1	245044	
A857	CV PLUG	SCP-13A-BLK(UK)	1	25056591	<MO>
A858	ANT COIL	NMA-3057	1	232140	
A859	FM ANT AS	Type W	1	292191	
A860	LABEL	(SPCABLE)2009	1	29390881	
A861	BATTERY	R6/AA(UM-3)	2	3010194	<EXCEPT MR>
A861 or	BATTERY	R6/AA(UM-3)	(2)	3010054	<EXCEPT MR>
A883	WRNTY CARD	(ONKYO-CH)	1	29365098B	<MR>
A884	WRNTY CARD	MGQ	1	29365099A	<MQ>
A885	WRNTY CARD	(ONKYO)	1	29365135	<DC, DD>
A888	LABEL	(APV)	1	29390190	<MR>
A901	INST SHEET	EnCs(Del_Battery_China)	1	29355760	<MR>

ONKYO CORPORATION

Service Dept. Technical Support : 2-1, Nisshin-cho, Neyagawa-shi, OSAKA 572-8540, JAPAN
Tel: 072-831-8023 Fax: 072-831-8163

ONKYO U.S.A. CORPORATION

18 Park Way, Upper Saddle River, N.J. 07458, U.S.A.
Tel: 201-785-2600 Fax: 201-785-2650 <http://www.us.onkyo.com/>

ONKYO EUROPE ELECTRONICS GmbH (DUISBURG OFFICE)

Hafennr.7602, Logport Office-Center, Bliersheimerstr.80B, 47229 Duisburg, Germany
Tel: +49-2065-90198-00 Fax: +49-2065-90198-40 <http://www.eu.onkyo.com/>

ONKYO EUROPE UK Office

Suite 1, Gregories Court, Gregories Road, Beaconsfield, Buckinghamshire, HP9 1HQ
UNITED KINGDOM Tel: +44-(0)1494-681515 Fax: +44(0)-1494-680452

ONKYO CHINA LIMITED

Units 2102-2107, Metroplaza Tower I, 223 Hing Fong Road, Kwai Chung,
N.T., HONG KONG Tel: 852-2429-3118 Fax: 852-2428-9039
<http://www.ch.onkyo.com/>

